

Extreme How-To®

The Enthusiast's Guide to Home Improvement

PRO TIPS

TO GET THE
MOST FROM
YOUR DECK

PLUS:

PLANNING A
BATHROOM REMODEL

SUPER SIMPLE TV SHELF

10 TIPS FOR
CAULKS & SEALANTS

March 2014 | www.extremehowto.com

\$4.99US \$4.99CAN

03>





www.MyTGTools.com

YOUR ONE SOURCE SOLUTION

FASTER EASIER CLEANER

KIK® Forstner Bit

KIK® HS Brad Point

KIK® Spade Bit

**135° Split Point start from Contact
3-flat shank, less chuck slippage**

Concrete



Stronger, Faster
Less Walking

High Speed



General Purpose

Titanium
Coated
High Speed



Longer Lasting

Heavy Duty



Heavy Duty
Steel Usage

Solid Cobalt



Heavy Duty
Steel Usage

S&D



Special Use Heavy
Duty Steel Usage

www.MyTGTools.com 1-800-687-4122

TG® Tools • 1010 Cedar Ave. • St. Charles, IL 60174 • ph 800-687-4122 • fax 630-584-4722

Here's Our **Crowning** Achievement

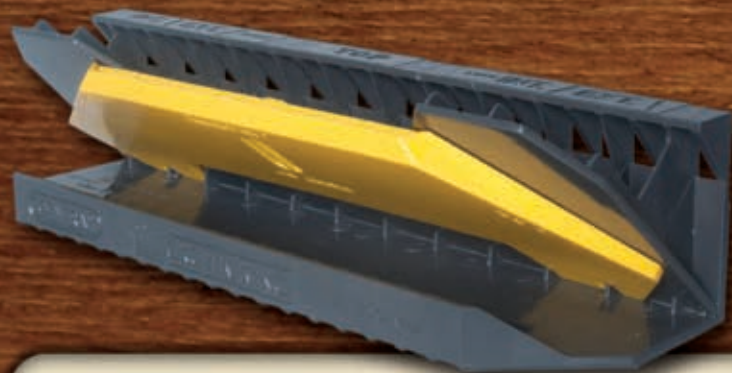

NEW Crown King
helps you create seamless,
perfectly mitered interior
and exterior corner joints.
#880

Now you can make it yours!

The **Crown King** makes cutting crown molding joints a snap, eliminating trial and error and saving time and money. Unlike competitive jigs that require confusing upside-down miter box positioning or compound angle cutting, the molding in the jig is cut in the same alignment as it is installed on the wall. With just one base unit and a reversible insert, the jig enables woodworkers to produce interior and exterior corner joints for the three most common crown molding spring angles—38, 45 and 52 degrees.

For more information on General's new Crown King and our complete line of E•Z Pro™ jigs, visit:
generaltools.com/kingandchiefs



Specialty Tools & Instruments

Precision, Specialty & Innovation...since 1922



Meet the Joint Chiefs



The E•Z Pro™ Mortise & Tenon Jig

lets you make perfectly matched mortise & tenon joints with one jig.

#870



The E•Z Pro™ Dovetail Jig

lets you make dovetail and box joints – through or half-blind.

#861

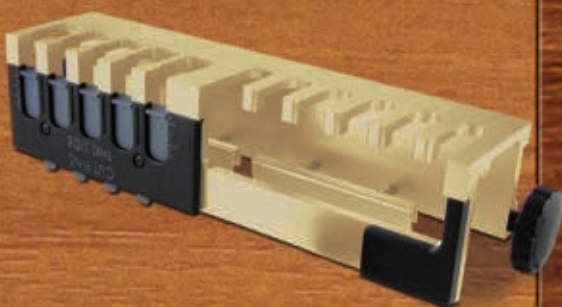

The E•Z Pro™ Pocket Hole Jig

has everything you need to make flush, corner and angle pocket hole joints.

#850



The E•Z Pro™ Doweling Jig

lets you make perfectly aligned dowel joints every time.

#851





TG
KIK
PRO SERIES

www.MyTGTools.com

YOUR ONE SOURCE SOLUTION

**FASTER
 EASIER
 CLEANER**

KIK® Forstner Bit



KIK® HS Brad Point



KIK® Spade Bit

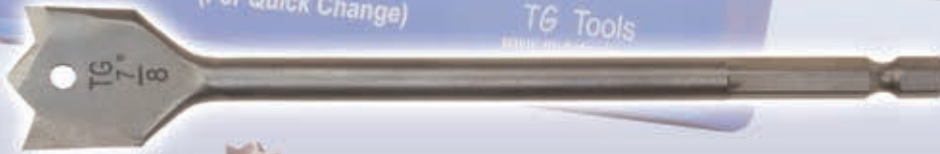

**135° Split Point start from Contact
 3-flat shank, less chuck slippage**

Concrete



**Stronger, Faster
 Less Walking**

High Speed



General Purpose

**Titanium
 Coated
 High Speed**



Longer Lasting

Heavy Duty



**Heavy Duty
 Steel Usage**

Solid Cobalt



**Heavy Duty
 Steel Usage**

S&D



**Special Use Heavy
 Duty Steel Usage**

www.MyTGTools.com/kik1.php **1-800-687-4122**

TG® Tools • 1010 Cedar Ave. • St. Charles, IL 60174 • ph 800-687-4122 • fax 630-584-4722

We Put a **KIK**[®] in Your Boring Tasks!

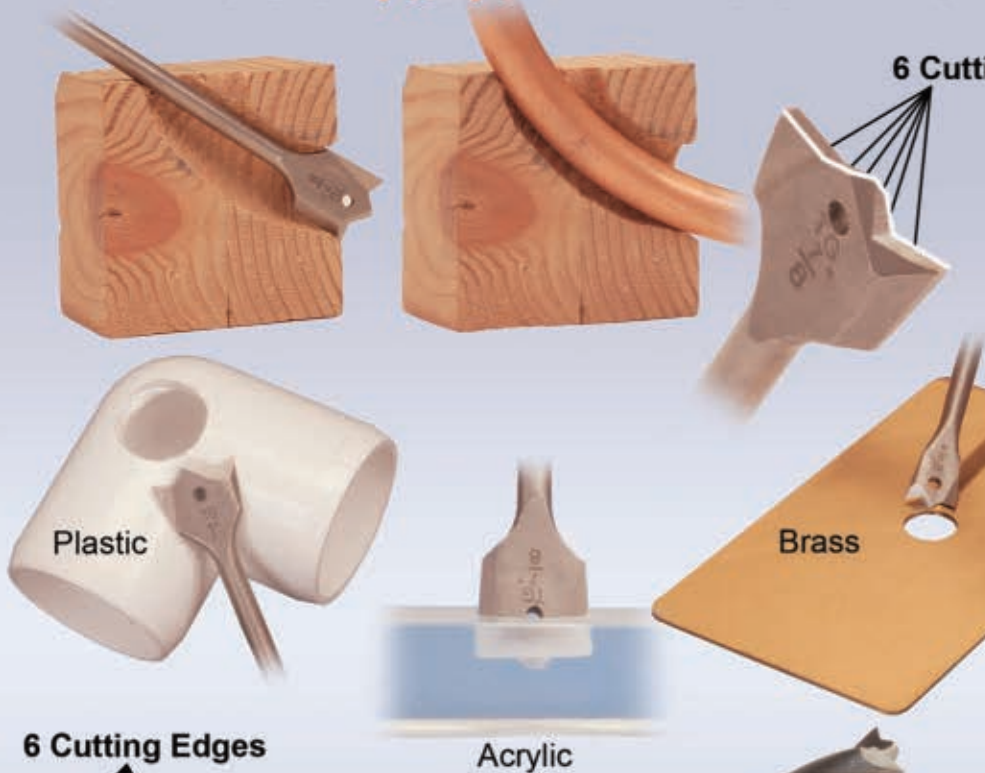

6 Cutting Edges

The revolutionary **KIK**[®] Spade Bit has over 30% more cutting surface making them much faster and longer lasting than standard spade bits. There is no protruding tang to bend or break allowing these bits to even bore non-ferrous sheet metals and curved holes too! Tested and Proven Superior by an Independent Lab.

6 Cutting Edges



KIK[®] HS Brad Point

Independent Lab Tested and Proven
Designed for Drilling Sheet Metal, Wood and Plastic Faster, Cleaner with Longer Life and no Walking on the Surface.



In Wood:

- **Approximately 100% Faster** Compared to Common Brad Point
- **40% Faster** Compared to Standard Drill Bits

In Sheet Metal:

- **50% Cleaner Entry**
- **Consistently Round Hole**
- **20% Less Walking**

In Acrylic:

- **No cracking** Drilling Acrylic
- **150% Faster** Compared to Standard Drills
- **690% Faster** Than Other Brad Points

KIK[®] Forstner Bit

Proven Superior by an Independent Lab
Cleaner Entry and Exit



9 Cutting Edges
3 on Each Blade

- **Titanium Coated**
- **3-Flat Shank**
- **Open Head Design** for no Clogging
- **Easy Drilling and Direction Control**

- **Bores through Hard Woods 100% Faster** Compared to Standard Forstners

- **Bores**
- **Mills**
- **Routes**
- **Cuts**

- **Bores Curved Paths**
- **Channels**

- **Bores Through Acrylics Cleanly Without Melting**
- **Able to Bore 90 Degree Curved Paths**

www.MyTGTools.com/kik1.php **1-800-687-4122**

THE WORLD'S TOUGHEST WIPES



BIGGER

Extra large 10" x 12" scrubbing wipes have twice the cleaning surface of typical wipes.

STRONGER

Our proprietary 9-cleaning-agent formula is a serious cleaning solution for serious messes.

TOUGHER

Our fiber weave wipe design is tough enough to withstand vigorous scrubbing.

Look for Tub O' Towels® at leading retailers, including:



True Value.

tubotowels.com

©2014 Federal Process Corporation. All rights reserved.

CONTENTS

March 2014

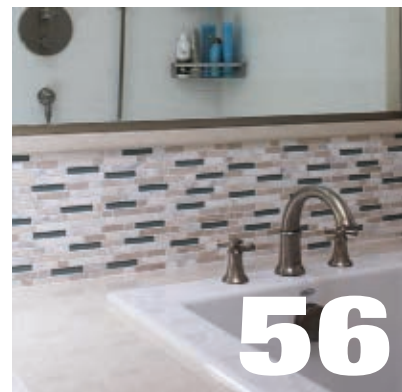

FEATURES

30 Pro Tips to Get the Most from Your Deck

Spruce it up for springtime.

42 Deck Product Roundup

It's soon to be deck-building season. Here are some new product highlights to help outfit your outdoor retreat.

56 Planning a Bathroom Remodel

Preparation, coordination and communication are your keys to success.

CALIBURN™ HEAVY DUTY CONCRETE & MASONRY FASTENER

Great for a wide variety of indoor/outdoor home renovation projects.

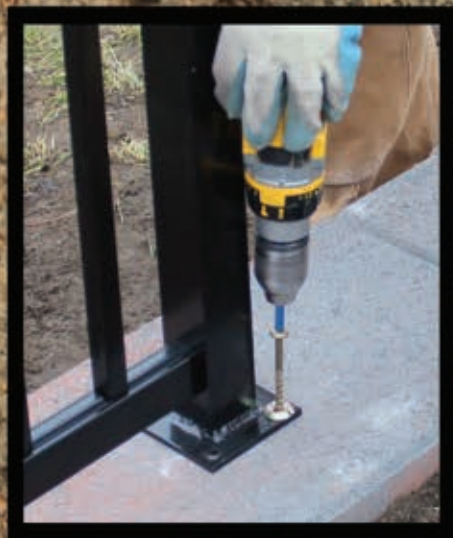

- ★ Recessed Star Drive that eliminates stripping and popped heads
- ★ Aggressive thread pattern traps dust keeping threads sharp the entire length of the screw for fierce holding power
- ★ Climatek™ coated for superior corrosion resistance

“Over-engineered to drive with confidence and peace of mind!”

GRK
FASTENERS™
ÜberGrade®

Visit our website for your
FREE SAMPLE of
Caliburn™
Concrete Screws!

www.grkfasteners.com
800.263.0463



CONTENTS

EVERY ISSUE

- 8** From the Editor
- 79** Advertisers Index

COLUMNS

- 10** Q & A
- 14** Tool School
10 Tips for Caulks & Sealants
- 26** Spotlight
Deck Ledger Code Changes

DEPARTMENTS

- 70** Quick Fix
Super Simple TV Shelf
- 78** Hot Products



Cover photo courtesy California Redwood Association

AGAINST THE GRAIN

ZAR® Deck and Siding Clear Wood Sealer and Toner is different from other clear sealers. The water based formula offers a superior resin package and one of the best warranties in the business. Specially formulated to resist mildew growth with the incorporation of a non hazardous, green biocide. The editors of Popular Mechanics were so impressed, they gave it their Editor's Choice Award.

For a dealer near you call
1-800-272-3235 or
visit www.ugl.com

Our other "Deck and Siding" products include
Solid Color Stain, Semi-Transparent Stain,
Deck Cleaner and applicators

STOPS LEAKS HERE



...AND HERE

Touch 'n Foam sealant products actually pay you back by keeping heat and A/C in the house where it belongs.

SEAL YOUR HOME WITH

Touch 'n Foam

- Fills gaps and cracks
- Stops drafts and energy loss
- Indoor and outdoor applications

Use smartphone scan or visit www.touch-n-foam.com for energy saving tips, to calculate your potential payback, and to find a retailer near you.



ENERGY TAX CREDIT ELIGIBLE

In this issue of *EHT* we turn to the pros for some expert advice on home improvement.

Rob Robillard, the "Concord Carpenter", contributes an article in which he demystifies the planning process for a bathroom renovation. A long-time residential contractor, Rob draws on years of experience from remodeling houses to guide you—and your contractor—through the critical planning phase of this common home project.

In addition to fixing up homes and writing for *EHT*, Rob also runs his own website, www.aconcordcarpenter.com, where he reviews tools and offers home-improvement tips.

Another respected construction pro, Mark Clement, lends his expertise to a story on how to get the most from your deck. A seasoned deck builder and home remodeler, Mark offers his professional perspective on the best ways to keep your favorite outdoor living space looking great and lasting longer.

When he's not laying deck boards or knocking out walls, Mark spends his time talking shop on his radio show, which you can find at www.myfixituplife.com.

These guys have a lot of expertise in their fields and a willingness to share it with others. Professional craftsmen are an excellent resource for information when you're tackling a tough project, and they can offer the kind of real-world suggestions that you won't find in a book. If you know any personally, don't be afraid to call them up and pick their brain about problems you encounter in your work. When it comes to

home improvement, there are no stupid questions, forewarned is forearmed, and advice is usually free.

If you don't know any pro remodelers, you can always send your question to us. Drop us an email or visit our blog at blog.extremehowto.com. If one of our staff members can't help you, we'll get in touch with someone who can ... like Rob or Mark.



EDITOR-IN-CHIEF

Matt Weber
mweber@latitude3.com

ADVISORY BOARD

Monte Burch
Rob Robillard
Larry Walton
Kathy Ziprik
Mark Clement

CREATIVE DIRECTOR

Wesley Glassco

CIRCULATION

Jennifer Pentecost

PUBLISHER

Jeremy Hollingsworth
jhollingsworth@latitude3.com

SENIOR ACCOUNT EXECUTIVE

Jan Logan
jlogan@latitude3.com

ADVERTISING SALES

Martin Smith
msmith@latitude3.com

Jason Holsomback
jholsomback@latitude3.com

Scott Shelley
sshelley@latitude3.com

ONLINE MEDIA ASSISTANT

Sonia Griffin

BUSINESS MANAGER

Dusty Statham

SUBSCRIPTIONS

Customer Service
888-587-8911

PRESIDENT

Trent R. Boozer

EXECUTIVE VICE-PRESIDENT

Chad Gillikin

EXECUTIVE VICE-PRESIDENT

Val Carrier

Extreme How-To is published by

LATITUDE3 MEDIA GROUP, LLC

1111 Edenton Street
Birmingham, AL 35242

Phone 205.949.1600 • Fax 205.949.1601
www.extremehowto.com

Extreme How-To (ISSN 1540-5346) is published and distributed monthly to DIY home improvement enthusiasts by Latitude3 Media Group, LLC, 1111 Edenton Street, Birmingham, AL 35242 (executive and editorial offices). All rights reserved. Neither this publication nor any part of it may be reproduced, stored in a retrieval system, or transmitted in any form or by any means, electronic, mechanical, photocopying, recording, or otherwise, without permission of Latitude3 Media Group, LLC. Subscriptions: U.S. and possessions: 1 year (9 issues - \$18.97); foreign, 1 year (9 issues - \$32.50) U.S. funds only. POSTMASTER: Send address changes to: *Extreme How-To* P.O. Box 4320, Oregon, IL 61061. SUBSCRIBER SERVICE: To order a subscription or change your address, write to *Extreme How-To* P.O. Box 4320, Oregon, IL 61061, or call 888-587-8911; or E-mail to ehw@pubdmgroup.com; or visit www.extremehowto.com. To order back issues, call (205) 949.1603.

The information in *Extreme How-To's* editorial content is intended to explain and simplify home-improvement tasks. Tools, products, materials, techniques, building codes and local regulations change; therefore, **Latitude3** assumes no liability for omissions, errors or the outcome of any project. The reader must always exercise reasonable caution, follow current codes and regulations that may apply, and is urged to consult with a licensed professional if in doubt about any procedures. **Printed in the USA**

RELAX...DUCKBACK HAS YOU COVERED!



OUTDOOR SUCCESS!
FOR ALL SEASONS AND ALL ENVIRONMENTS

DIY FRIENDLY COATINGS WITH CONTRACTOR GRADE RESULTS

Deck restoration made easy! With Superdeck you can clean, stain and beautify in a few easy steps, allowing you to spend less time on projects and more time enjoying your home improvements.

Superdeck Wood Stains

- One coat coverage protects and beautifies
- Transparent iron oxide pigments for maximum color and UV protection
- Three oils gives wood the famous Superdeck glow
- Superior protection and water repellency



DUCKBACK
Live the Outdoors!™

SUPERDECK.COM 1-800-825-5382

Q: When should I begin feeding my lawn for spring?

A: Fertilizing a lawn is a great way to boost the health of the root system to combat heat, cold, drought and other stresses. Plan a feeding in early spring (February to April) to strengthen the lawn's roots for a strong start before the heavy growing season. If the lawn had crabgrass last year, apply a combination fertilizer with a pre-emergent. In late spring (April to June), the growing grass is using stored energy, which necessitates another feeding. If broadleaf weeds are growing too, then feed the lawn with a combination fertilizer with broadleaf weed control (a "weed-and-feed" product).

Q: If I install a pet door, will I get a lot of air intrusion into the house?

A: Today's pet doors have spring-loaded, flexible flap doors with strong magnets that close and seal the door from weather. Some pet doors even utilize an RFID (radio-frequency identification) tag in the pet's collar. As the pet approaches the door, the RFID tag sends a signal that unlocks the door and then relocks it after the pet passes through.

READY SEAL

STAIN AND SEAL LIKE YOU MEAN IT.

Protect, beautify and prolong the life of any outdoor project with Ready Seal®, the professional-grade stain and sealer in one. Ready Seal goes on with no laps, runs or streaks for perfect results, every time. Available in one and five-gallon sizes.

MAHOGANY-030	DARK WALNUT-025B	REDWOOD-020	
GOLDEN PINE-100G	LIGHT OAK-005	NATURAL CEDAR-012	PECAN-015B

ORDER ONLINE OR BY PHONE
www.ReadySeal.com | 888.STAIN4U



Scan this code with your smart phone QR reader to view our website.





**Best
Prices**

**Highest
Quality**

**Biggest
Selection**

**Expert
Advice**

*340+ varieties to
choose from*

Schön - Old Castle Sapele Engineered



Scan, call or go online
for a FREE CATALOG
<http://goo.gl/AL7pm>

HARDWOOD FLOORS FOR LESS!
**LUMBER
LIQUIDATORS**
www.lumberliquidators.com
1-800-HARDWOOD

*We have 340+ varieties of flooring
to choose from. In technical terms...*

...that's more flooring than you can shake a "plank" at.

Solid hardwood, laminate, bamboo and more—if it's flooring, we've got it. We have top brands at the lowest prices around, and it's all backed by real flooring expertise. Sure, you could go to a big box store looking for the same wide variety. But you'll soon find out, you're barking up the wrong tree.

Drop by your local Lumber Liquidators store and get more floor for less.

Q: What is the difference between three-tab roof shingles and "architectural" shingles?

A: In roofing, the term "architectural" generally means the shingle has a three-dimensional design and construction. A true architectural shingle will have more than one thickness to provide enhanced aesthetic appeal. The dimensional design creates a shadow line that gives the roof the appearance of slate or wood shake.

Q: How do I calculate the amount of roofing shingles needed for a roof?

A: Roofing material is calculated by taking measurements of each roof section (length x width) and adding them all together to calculate the area of the entire roof in square feet. Triangular sections of a roof, as with hip roofs, can be computed by multiplying the ridge length by the height of the side, then dividing by half. Add together the area of all the sides of the roof, and then add 10 to 15 percent to account for waste. Roofing shingles are sold by the "square" (100 sq. feet), so determine the number of squares of shingles needed by dividing the total area by 100. **EHT**

EarthWay
SPRAY-PRO

S15 SPRAY-PRO[®]
Ground Driven
Push Sprayer

Features:

- **SPRAY-PRO[®] high-speed pump**
- **5gal/22L tank capacity**
- **10" Pneumatic wheels**
- **Fully assembled steel chassis**
- **3 Interchangeable nozzles**

For information, call 1-800-294-0671 or visit www.earthway.com to find a dealer.

EarthWay
MADE IN THE USA



BRUSH WEATHERSTRIPPING for HOME & GARAGE

Energy-efficient and Environmentally-friendly | Helps reduce heating and cooling costs

Ideal for all types of doors: Entry, Garage, Barn, Hangar

- Effective air seal
- Won't crack or tear in extreme temperatures
- Perfect for uneven surfaces and cracks
- Durable – won't degrade over time (may last the life-time of your door)
- Deters pests – a physical barrier, blocks light and odors that attract pest

 **BRUSH**Weatherseal.com

brushweatherseal.com | 855.225.8892

10 Tips for Caulks & Sealants

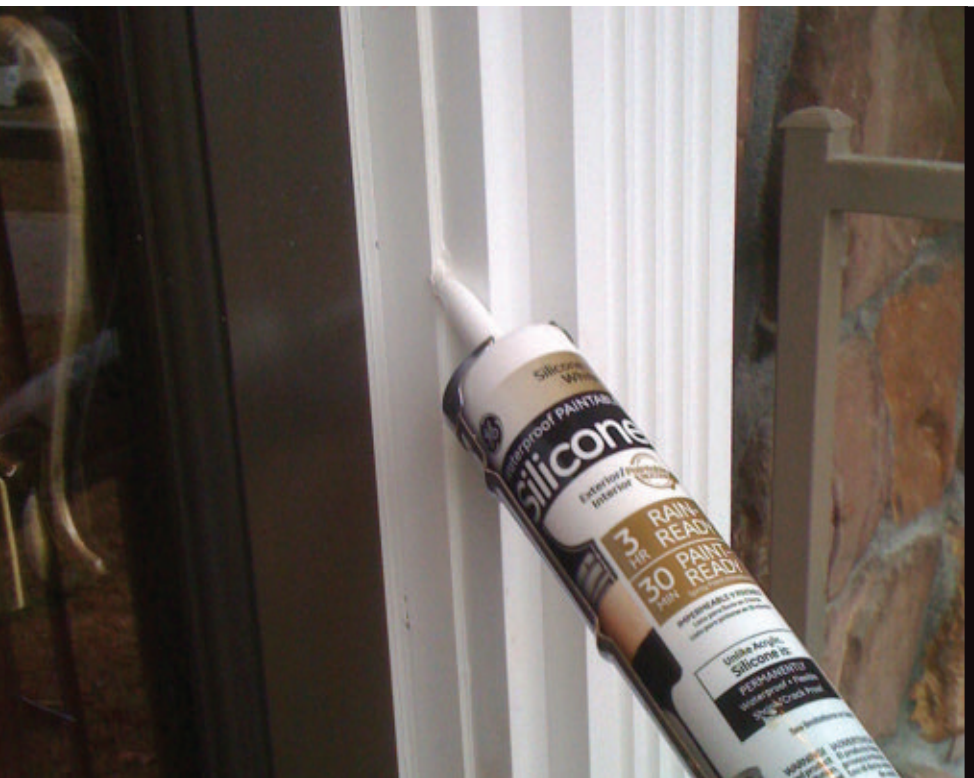

Siliconized caulk has long been a favorite for sealing areas exposed to moisture and the elements.

and not intended to serve as a sealant, but it is also the least expensive option.

These days, many caulk/sealant products come in hybrid formulations containing some of the attributes of both silicone and acrylic, meaning they can be cleaned or tooled more easily, remain flexible, can be painted and still retain a waterproof seal.

Complicating the selection further is the advent of water-based and solvent-based caulk/sealants that have similar hybrid properties, and many of these new sealants serve double-duty as adhesives. Like silicone, solvent- and water-based sealants work well in wet areas where accumulated water would deteriorate acrylic latex.

For use around electrical wires and fixtures, use a fire-resistant caulk as an additional safety measure.

The easiest way to parse the many options is to pay close attention to the indications on the packaging, making sure they match the job at hand. Whether the product is waterproof, paintable or contains a mildewcide additive, all features of the product should be listed prominently on the label.

2. Clean Caulking. Before applying any caulk or sealant, clean the surface of the work area thoroughly. This commonly overlooked step will prevent grit and debris from disrupting the application of the bead and keep unsightly dirt and

By Matt Weber

Applying caulk: It's a messy job, but someone's got to do it. Whether it's an interior or exterior application, *EHT* offers 10 tips to help seal your joints with success.

1. Sealant Selection. When it comes to sealing joints for a trim installation or to weatherproof windows, choosing the right caulk/sealant is the first order of business. Silicone-based sealants have long been the staple for exterior projects where a waterproof seal is necessary. However, standard silicone cannot be painted and is incredibly messy and sticky to use. Newer formulations of silicone-based sealants can be painted—but only if indicated on the packaging—so pay close attention when buying.

Many pros now prefer polyurethane-based sealants for siding, windows and doors, because it stays flexible and doesn't shrink, it has better adhesion than silicone—plus, it's paintable.

Silicone sealants work well for use in the kitchen and bath. They can be purchased with antimicrobial additives to fight mold and mildew, and can be easily removed and replaced when the bead gets grimy.

Acrylic caulk is only appropriate for interior projects and is not waterproof, nor is it very flexible and may crack over time. However, acrylic caulk can easily be painted and is much easier to tool and clean up than silicone. Standard acrylic caulk is primarily decorative

Give your wood a **MAKEOVER**



Amber Stain on teak and PT pine

Photo courtesy of Beth and Rod of See Dirt Run!

Professional grade yet homeowner friendly

ARMSTRONG'S WOOD STAINS

Long Lasting, Easy to Apply and a Breeze to Maintain

Manufacturers of VOC-Compliant, Oil-Based Wood Finishes

www.armclark.com • (800) 916-8211

PLEASE VISIT THE WEB'S PREMIERE SITES FOR OUTDOOR WOOD RESTORATION TOPICS AND DISCUSSIONS,
www.thegrimescene.com/forums www.thewoodpros.com



arke
fontanot

SPIRAL STAIRS AND MODULAR STAIR CASE KITS

AVAILABLE THROUGHOUT
THE USA, ARKE SPIRAL
AND MODULAR STAIRCASE
KITS CAN BE BUILT IN A
DAY BY THE AVERAGE
DO-IT-YOURSELF HOME
ENTHUSIAST.

THE KARINA MODULAR SPACE SAVER STAIRKIT IS A UNIQUE AND
STYLISH SOLUTION FOR NARROW ACCESS AREAS, SUCH AS LOFTS
OR ATTICS, WITHOUT COMPROMISING FUNCTIONALITY.

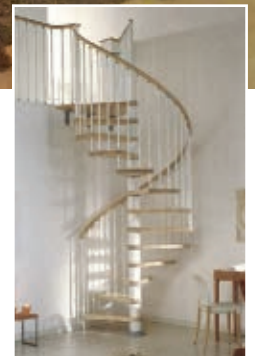
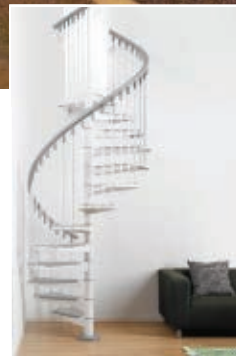

ARKE MAKES BUYING AND INSTALLING A SPIRAL STAIR CASE EASY WITH THE FOLLOWING KEY FEATURES:

- ALL-IN-ONE COMPLETE UNITS: TREADS, LANDING, BALUSTERS, HANDRAILS, HARDWARE AND ACCESSORIES INCLUDED
- NOTHING TO PAINT, WELD, STAIN OR SEAL
- IN STOCK FOR IMMEDIATE DELIVERY

www.arkestairs.com

5. Spray it Smooth. One option for shaping a caulk bead comes in the form of sprayable release agents, such as Caulk EZ. With these products, spray the completed caulk joint, holding the can or bottle 4 to 6 inches away. The release agents prevent the caulk from sticking to the areas you spray and make shaping the joint much easier.

6. Tools for Tooling. A simple caulk shaping tool is a short wooden dowel (or a variety of dowels of different sizes to create beads of varying sizes). Wet the wood and draw the round end of the dowel over the caulk bead to scrape away excess product and press the bead into a concave shape. Another option is a shaping tool such as the Hyde Caulk-Rite Pro Tool. These new rubberized shaping tools have a large enough working surface to clean away most of the excess caulk while



Waterproof caulk can be used to fill small cracks in tile grout.

HOWARD "Restore It - Don't Strip It!"



- Blends Out Scratches
- Restores Color & Luster
- Eliminates White Heat Rings
- Revives Minor Crazed Finishes
- Revives Faded Finishes
- Removes Water Marks

Available At:



www.HowardProducts.com • (800) 266-9545

OUR severe weather solution.

MIAMI-DADE COUNTY
APPROVED



MAZE ring shank HDG roofing nails are Miami-Dade County Approved.



MAZE roofing nails are available in bulk for hand driving and coils for pneumatic tools.



MAZE roofing nails are 100% MADE IN THE USA.

MAZE roofing nails are available in double hot-dipped galvanized, stainless steel, copper and aluminum.

MAZE ring shank roofing nails provide more than twice the holding power of smooth shank nails.



NAIL IT ONCE. NAIL IT RIGHT.®

1.800.435.5949 • mazenails.com
Celebrating 165 Years • 1848-2013

A Division of W.H. Maze Company
Helping to Build America Since 1848

Manufacturing 100% Made in the USA nails with pride, honor and tradition.

offering a variety of bead shapes, and leaving no edge marks. Shaping tools are easy to use and wipe clean when done.

7. Caulk a Tub. When caulking a bathtub, first fill the tub with water. The weight will pull the tub downward, maximizing the size of the

joint. Apply the caulking along the edge of the tub in full contact with both vertical and horizontal surfaces. This prevents future stress and cracking of the caulk joint. Once the bead is dry, drain the water.

8. Remove Old Sealant. To remove a grungy bead of silicone for replacement, cut through each side of the bead with a utility knife and pull it away by hand. If you're lucky, most of the bead will stay intact as a strip. To remove any remaining sealant, scrape it with a paint scraper held at a shallow angle. Finish up by scrubbing the surface with mineral spirits and an abrasive pad to get rid of any residue. Once clean and dry, apply a new bead.

9. Seal Big Joints. To seal a joint larger than 1/4-in. wide, use

To remove old silicone caulk, cut the bead along each side with a utility knife and pull it from the joint. Carefully remove what remains with a paint scraper held at a shallow angle.

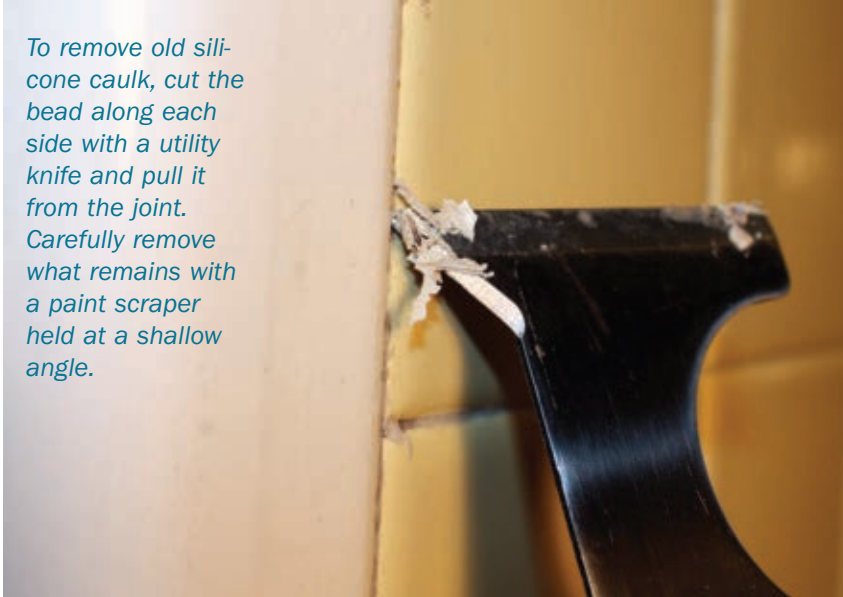

DURABILITY you can drive on.



Transform your garage in one weekend.

Check out our how-to video!



**Step 1
CLEAN-N-ETCH**



A 2-in-1 cleaner & etcher that prepares concrete for proper adhesion of garage floor paint.

**Step 2
LOCK-DOWN**



Concrete bonding primer that improves paint adhesion by 50%.

**Step 3
EPOXY-SEAL**



Concrete and garage floor paint that is 3x stronger than other floor paints.

**Step 4
CLEAR-SEAL**



A protective sealer that adds a beautiful finish and extends the life of painted concrete.

www.seal-krete.com

HOW TO TREAT CONCRETE®

800-323-7357

Bellaforté[®]

by DAVINCI



Bellaforté roofing tiles have all the appearance and beauty of natural slate or shake, but with a higher level of durability from the proprietary-engineered polymer roofing formula. The tiles are designed for fast, easy installation, while protecting against the elements for decades to come. Bellaforté offers the discerning homeowner a level of style and beauty previously unattainable, backed by a 50-year limited warranty and made in the United States.



CLASS A Fire Rating

EASY INSTALLATION

50-YEAR WARRANTY

SLATE & SHAKE STYLES
to choose from in a wide
variety of color blends

VIRTUALLY
MAINTENANCE FREE



The Art & Science of Lasting Beauty

www.davinciroofscapes.com

a foam backer rod as a filler before applying the caulk. Less expensive than caulk, the rods provide a cheaper way to fill the empty space than using caulk

alone. Plus, when caulk is applied over a backer rod, it forms an "hourglass" shape with large surface areas of adhesion at the sides of the joint. The hourglass

Masking the joint with painter's tape can create a crisp caulk line with minimal mess.



shape of the caulk bead withstands joint movement better than any other configuration. Furthermore, because there is no caulk adhesion at the rear of the joint, the joint is less susceptible to stresses that cause early failure.



SMART ELASTOMERIC CAULK & SEALANT

With no harmful, irritating fumes, SMART Elastomeric Caulk & Sealant from Gardner-Gibson is a premium zero-VOC caulk that is ideal for occupied spaces. It promotes cleaner air for all; especially seniors, children and allergy and asthma sufferers. This crack-resistant seal is great around doors, windows, baseboards, moldings, countertops, trim and other adjoining surfaces. Apply on painted or bare surfaces, including wood, metal, brick, concrete, plaster, masonry, dry-wall or ceramic surfaces. It's compatible with all latex and acrylic paints and cures quickly to speed topcoating. The SMART zero-VOC product line also includes primer and spackling. Visit www.gardner-gibson.com.

Professional Deck Builders demand the best...



Shroomless for Composite Lumber



Color Headed Stainless Screws for Vinyl Decks



Ejector Stainless Screws - NO pre-drilling in Exotic Hardwoods



Superior Stainless & Carbon Screws for Traditional Decks

MURO
the premium solution

1-800-665-6876
www.muro.com

Speed DRIVER

Ultra DRIVER

Ejector
Tropical Hardwood Screw

Shroomless



Shield-Guard
Premium Deck Screws

Good for you, good for the environment.

When installed in a permeable pavement system our permeable clay pavers allow rainwater to filter through and dissipate into the soil rather than carry excess pollutants into storm drains and waterways.

Strong - 12,000+ psi

Durable - life cycle of 100+ years

Colorfast - no pigments or dyes



Pine Hall Brick

earth friendly...naturally green

www.americaspremierpaver.com

800.334.8689



StormPAVE

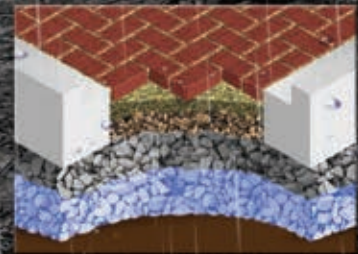

10. Get the Last Drop. Because the plunger on most caulking guns doesn't extend all the way to the end of the tube, roughly 1/2 inch of caulk usually remains at the bottom and ends up in the trash. To salvage this last bit of usable product, remove

the tube from the gun and use a short section of 1-1/4-in. thick dowel or a narrow wood block as a plunger extension. Drop the extension in the tube, replace the tube in the caulk gun, and depress the trigger until the tube is completely empty. **EHT**



Squeeze out the last bit of caulk from your tube by using a wood block or dowel as a plunger extension.

SASHCO SLAB

Some caulk/sealants are formulated for special application. Sashco's Slab concrete crack repair caulk combines superior adhesion and elasticity for extra durability. It's an environmentally friendly product with a water-based formula that's easy to apply and clean up. Slab spans gaps up to 3 inches wide and offers the flexibility you need for lasting concrete crack repairs. Visit www.sashco.com.



Barn Door Hardware

for Interior use



Spade
10.5" H
x
3" W

Fleur-de-Lis
11.75" H
x
3.25" W

Vista
2.5" W x 6.25" H

Palm-Lis
2.625" W x 8.625" H

Double Horse
4.625" W x 8.625" H

GingerBread
3.625" W x 8.25" H

Wright
2.25" W x 7.625" H

Ice Cream Cone
4.875" W x 8.625" H

Kaminski Wolf
4.875" W x 8.625" H

Top Mount
4.75" W x 4.5" H

Circles
2" W x 4.86" H

Horseshoe
4.12" W x 6.17" H

**Call for pricing,
details on how to
order, availability.**



**10% OFF ALL ORDERS ON
ROLLING BARN DOOR HARDWARE.**
Mention **EHT 2013** in order to

800-882-0009

1170 Wauwatosa Road Cedarburg, WI 53012

www.cshardware.com

*The Single Best Value In
Preventative Maintenance*



▲ *Damage Caused By Conventional Boot Failure*



PERMA-BOOT

Old-fashioned rubber boots around plumbing vent pipes can deteriorate when exposed to sun and temperature extremes causing them to crack and leave a gap where water can enter.

Perma-Boot® Is The Fast & Permanent Solution.



*Call Store for Availability

MANNING
BUILDING PRODUCTS

108 Professional Court • Garner NC 27529 • (919) 662-9894
Perma-Boot.com

MADE IN THE USA 

Deck Ledger Code Changes

New Requirements to Resist Lateral Loads



Let's say you own a house with a finished basement and no deck. Let's say you'd like to add a deck by attaching it to your house using a ledger board. Well, depending on where you live, your job may have just gotten significantly more difficult.

Changes to International Residential Code for projects where decks are supported by an adjacent structure (your house), now require a "positive attachment" to resist lateral loads. That positive attachment is a new piece of hardware called a hold-down device "with an allowable stress design capacity of not less than 1,500 pounds", which must be installed on at least two locations per deck (IRC 2012 Section R507.2.3).

These new hold-down devices must be attached to the joists of the deck, penetrate through the ledger board, the wall sheathing and band joist of the house, and then fasten to the floor framing inside the house.

So, if your home has finished walls, ceiling, cabinets, etc., blocking access to the home's floor framing, then to satisfy the new code requirements you'll need to deconstruct the interior to gain access. Naturally, this code change requires more labor, hardware and expense to building a

new deck, and in some circumstances it may result in even further cost increases to the project, because the homeowner will need to repair the disturbed interior living space.

The change in code was spurred by deck failures caused by ledgers that pull away from the house

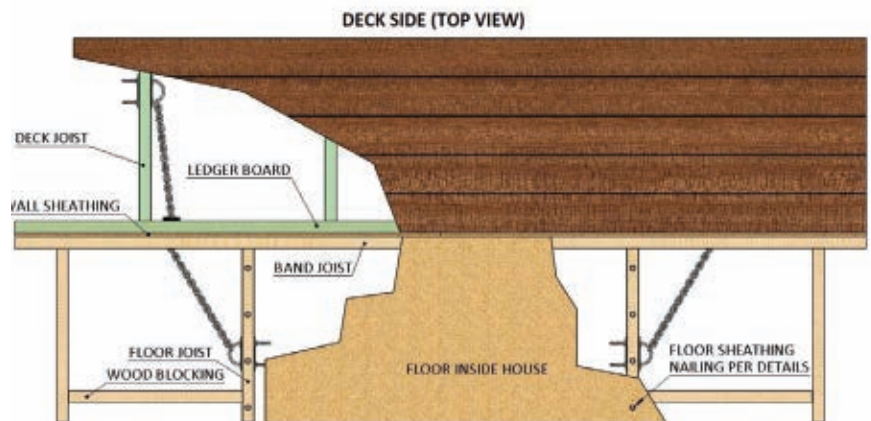

The flexible chain of the GRK Deck Harness allows positive connection of house/deck joists that are not aligned.

Visit us at the 2014 IBS SHOW
BOOTH #C6113

SMART, STYLISH SOLUTIONS FROM FYPON



FOR HIGH-QUALITY, LOW-MAINTENANCE POLYURETHANE
AND PVC MILLWORK, FYPON HAS YOU COVERED.

FYPON
It's How You Finish.™

800.446.3040 · www.fypon.com · info@fypon.com

SPOT LIGHT

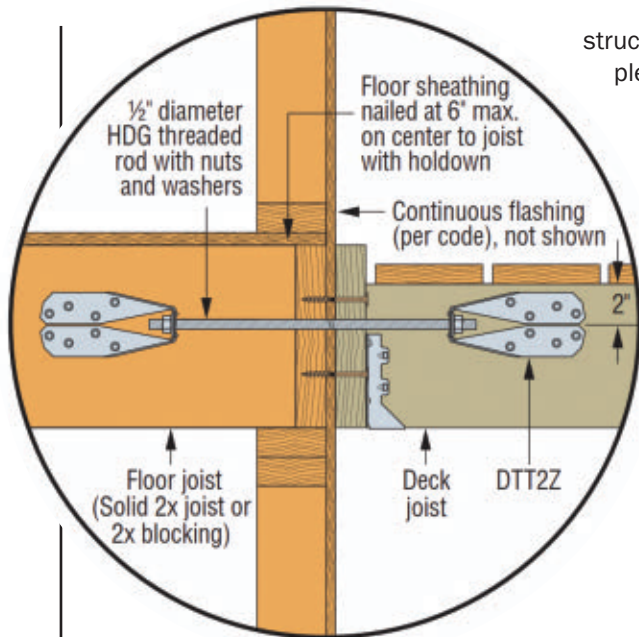

The Simpson Strong-Tie method utilizes a rigid threaded rod connected to two DTT2Z tension ties to satisfy the code requirement.

structure, resulting in complete collapse. These problems are generally due to improper flashing and/or improper fastening that lead to water accumulation and rot at the ledger connection, weakening the structural integrity.

When properly protected with flashing, a bolted ledger-to-rim board connection—or a connection

fastened with properly spaced and staggered wood structural screws—is a suitable connection to support the gravity load of a deck. However, the new hold-down devices are required to resist *lateral* loads, as required by your local building code. In such a case, the devices should be used to tie the deck joists directly to the house joists.

Whether or not the code change applies to your project depends on whether your municipality has adopted the IRC's code change. Deck construction must always conform to local building codes and may also require a building permit. In general, building codes are developed by industry associations "to provide minimum safety standards for a home's occupants,



Westbury
aluminum railing

- Square and Round Spindle Designs
- Level, Corner and Stair Crossover Posts
- Adjustable Aluminum Post Mount
- Over 11 Standard AAMA 2604-05 Colors
- ADA Compliant Continuous Handrail
- Lifetime Limited Warranty



www.westburyrailing.com
1-800-446-7659



Snapp System
screen

US Patent 9,484,926

Now Available In
Extruded Aluminum
& Flexible PVC

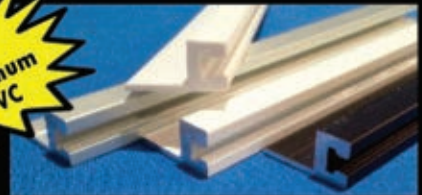

Commercial Grade Insect Screening Extrusion
Adapts To Almost Any Shape Opening



Connecticut Screen Works, Inc. 203.741.0859

www.snappscreen.com

Distributor Inquires Welcome

the environment and the public at large."The codes are adopted and enforced by local governments and vary based on local political issues, environmental regulations, etc. Check with your local building inspector to determine all local requirements.

If your local code requires installation of the hold-down devices, you have a couple of hardware options.

The lateral-load connection from Simpson Strong-Tie consists of two DTT2Z Deck Tension Ties—one screwed to the deck joist, the other to the house joist. Access is drilled through the ledger connection to allow passage of a rigid threaded rod that connects the two ties. This is a sturdy connection that meets the new code requirement and works well for

deck joists that align with the house joists.

However, deck joists don't always line up with the house joists, and the Deck Harness from GRK Fasteners has the advantage of flexibility. By utilizing a chain instead of a rigid rod, it's much easier to adjust placement of the GRK anchors, enabling connection to offset joists, perpendicular joists or to wood blocking. The Deck Harness consists of a steel chain-linked assembly with a thermoplastic plug in the center that installs through the ledger connection. One end of the Deck Harness is attached to the house floor joist with a U-bolt and washer plate. The other end of the Deck Harness is attached to the deck joist with identical U-bolt and washer plate. The GRK Deck

Harness is recognized in the ICC (International Code Council) Report ESR-3224.

The other advantage of GRK's system is that the insulated plug prevents moisture and frost from building up on cold steel and causing a rot problem where the device enters the house. Rotting of the ledger is one of the problems with deck collapses, and the very reason for an additional support to hold the deck up.

In the event of deck failure and the deck separates from the house, these new lateral hold-down devices prevent it from completely collapsing. **EHT**

Learn more about the deck ledger fastening options at www.grkfasteners.com and www.strongtie.com.

TRAC VAC

Quality Lawn Vacuums, Lawn Equipment, & Lawn Accessories



A vacuum to fit your need, we offer a range of vacuums from **5.5HP mounted** units to **11HP tow behind** units.

For more info call:

Palmor Products, Inc.

1-800-872-2822 or visit us on the web at trac-vac.com

DECK2WALL™ SWS spacer

Designed for **Structural Wood Screws**
 IAS Accredited Lab Tested
 Fastening Tables Available



NEW PRODUCT
 Easy to Install
 No Pilot Holes Required

Don't let your deck rot your house!

Use Deck2wall Spacers for the Ultimate

Ledger Connection Protection™

DECKS UNLIMITED
 Toll Free 888 577-2237
www.deck2wallspacer.com
 US PATENTS
 6,945,004 AND 8,087,207



PRO TIPS

TO GET THE MOST FROM **YOUR**



Photo courtesy California Redwood Association

Spruce it up for springtime.

By Mark Clement

No matter the material, all decks and porches require some maintenance. The good news is that regular upkeep is an easy way to preserve your wood deck's beauty for years to come. Since wood comes from nature, it's naturally at home in the outdoors. When properly finished and maintained, many wood varieties will last for decades, even in harsh environments.

To get the most out of your deck, once a year, take the following steps:

1. Inspect the boards for damage such as splitting, warping and major checking ('checking' is cracking parallel to the grain, i.e. "the long way"). An important step here is to check each fastener to be sure none are coming loose. This may require walking the deck back and forth along the joists, to sense any weakness or instability. This also presents an opportunity to check railings and bannisters by pushing them to make sure there is no give.

2. Check that the flashing is still sound and be prepared to replace this essential component if necessary. Flashing is a metal or plastic guard that directs water out and away from sensitive areas (areas prone to hold moisture and thus weaken). Properly installed deck flashing should be roughly "L"-shaped. One leg of the L runs up behind the siding. The other over the top of the board that connects to the house (this is called the 'ledger board').

PRO TIPS

TO GET THE MOST FROM **YOUR DECK**



Photo courtesy California Redwood Association

Remember, flashing is often installed where the deck and house come together, and its purpose to keep moisture and debris from collecting between the house and the deck's ledger board. Pay special attention to any areas that tend to remain damp, are regularly exposed to water (like exposed end-grain on post tops), or are in contact with fasteners. These are areas of stress that need to be carefully examined. Even if no signs of deterioration are present, you still may want to consider proactively adding or replacing flashing if you notice areas in which a significant amount of water is collecting.

3. Check the framing connections. Where the joists meet the ledger board, there should be metal hardware (joist hangers). Nails driven at an angle ('toe-nails') are not a sufficient structural connection. Bolts in post and

beam connections should be 1/2-in. diameter and galvanized.

Check that stairs are of proper rise and run. The combined rise and run of a code-approved stair should be no more than 17-inches: ideally 7-in. rise, 10-in. run (tread depth). Check that they're properly connected to the deck framing and that stair nosings are intact.

Posts, beams and angle bracing should be of appropriate size and spacing. Your local building inspector will be able to tell you what's expected where you live. Generally speaking, however, deck posts should be a minimum 6x6 spaced 6 feet on center.

If you can get under the deck and inspect the ledger, check that proper fasteners—bolts, 1/2-in. galvanized lag screws or structural screws like the RSS screws from GRK Fasteners—not nails—have been used where the deck attaches to the house, since this is a

common source of deck failure.

You will need to replace fasteners that show any signs of significant rusting or corrosion. This is



Make deck maintenance a routine part of your spring or fall clean up and you'll enjoy your favorite outdoor living space for years to come.

Redwood. Strong.



Redwood's reputation as a reliable building product is well earned. History has proven that redwood can stand up to the elements for decades. When it comes to choosing between natural redwood and man-made plastic decking, why choose artificial wood when you can have the real thing? Only genuine redwood delivers beauty and durability that comes from nature. It's the natural choice for your decking, fencing and outdoor living projects.

Get Real.
Get Reliable.
Get Redwood.



THE
CALIFORNIA
REDWOOD
COMPANY.

Find a retailer in your area at californiaredwoodco.com



PRO TIPS

TO GET THE MOST FROM **YOUR DECK**



An important first step in deck maintenance is to check each fastener to be sure none are coming loose.

because a corroded fastener can cause deterioration in surrounding wood. Check for nails that have lifted and for screws that show signs of significant deterioration, and replace as needed.

4. Every deck should have an annual cleaning. With regular maintenance, the weathered look of decks usually can be revived with the application of the right deck cleaner. Even if your deck is several years old and showing signs of natural weathering, it's easy to restore the original color and beauty of the wood by applying a cleaning solution and wood brightener. (As with all products, be sure to follow the manufacturer's guidelines for proper use and to make sure you are using the right product for your deck's wood species.)

Over 950 Woodworking & Furniture Screws

Trusted By Professionals

Full Line of Drive Bits

Magnetic Bit Holders

Solar Division

Adjustable Hook for Spanish or Flat Tiles With or Without Batons

180° Spanish Tile Roof Hook Now in Stock!

Flashed L-Foot Fast Easy Economical

Warehouses in California & South Carolina www.quickscrews.com

Deck cleaners and restorers generally fall into one of three categories—chlorine bleaches, oxygen bleaches, or oxalic acid-based formulas. Chlorine bleaches are especially effective for killing mold and mildew spores, a common cause of stains and discoloration. Oxygen bleaches are effective at removing mildew stains and weathered gray residue from sunlight-degraded wood decks. Oxalic acid products are useful brighteners for a wood deck, but not effective for removing mildew.

If you have a mildew problem, treat your deck with an oxygen or chlorine bleach and water solution (typically 1:3, bleach to water) first and follow it up with an oxalic acid-based product to brighten the wood color. Products with oxalic acid and bleach are also available.



Replace loose fasteners with quality decking screws or spiral/rink-shank nails. Also, inspect the framing connections beneath the deck.

Clamping Technology | Cutting Technology | Precision Steel



Simply better.

For 120 years now, whether it is clamping, cutting or steel technology, BESSEY® offers superior innovation, customer service and product quality.

Make the most of our innovative edge and accumulated experience and see for yourself why BESSEY® is... "Simply Better".

Join us on...

YouTube <http://www.youtube.com/user/BesseyTools>
 Facebook <http://www.facebook.com/BesseyToolsNorthAmerica>
 E-Newsletter <http://eepurl.com/erGnk>
 Website <http://www.besseytools.com>
 For information call - 1-800-828-1004

RAPID ACTION CLAMP

The Rapid Action Clamp comes with a double spindle mechanism (for accelerated clamping action) and a guided clamping bolt for very direct pressure. A robust tool to enhance shop productivity.

BESSEY® Simply Better.



AV2 SPACER

With adjustable settings (5-20 mm), durable construction and a wide contact surface area, the AV2 Floor Spacer is a big improvement over wedges or scrap wood for the laminate flooring professional.

BESSEY® Simply Better.



AV2 Video



AUTO-ADJUST TOGGLE CLAMP

The BESSEY Auto-Adjust Toggle Clamp automatically adjusts to variations in work piece dimensions while maintaining constant clamping force from 25 to 550 lbs.



BESSEY Tools offers two horizontal versions and an Inline version with new offerings coming Fall 2012.

Toggle Video



PRO TIPS

TO GET THE MOST FROM **YOUR DECK**

They will work on deep stains, mold and mildew but these are commercial-grade products and should be handled very carefully. Plants should be pre-rinsed and/or covered. And

siding or doors at the house may need to be shielded so as not to remove or damage their finish. Mold and mildew may require an additional round of scrubbing and application of both Oxalic acid and

household bleach/water solution. For some decks, you might decide to use a powerwasher. However, it is a good idea to check the industry association website of the wood species (pine, redwood, cedar) you are working with to determine if powerwashing is recommended for your deck. If you are powerwashing, always use as low a pressure as possible—between 500 to 600 psi. As a rule of thumb, try to never get closer than 12 inches to the wood deck.



Deck cleaners and restorers generally fall into one of three categories—chlorine bleaches, oxygen bleaches, or oxalic acid-based formulas.

Got Leaks?

Spray on **Rubber-Flexx™**, the new instant Leak Stopper for fast, easy repair of gutters, pipes, skylights roofs, and more.

See more great solutions at www.gardner-gibson.com

At hardware and home improvement stores nationwide.



Roof Cements & Coatings,
Driveway Coatings
and Sta-Kool® White Elastomeric Coatings



**14" Covers
DO MORE**

**TRADITIONAL
9" Cover**

BIGGER IS BETTER!

Faster, Smoother Results

Only Wooster has the big names in paint rollers—the brands that provide the finest finishes and highest production in the industry. Wooster also has 14-inch covers in the most extensive range of fabric choices you can get! Our **14-inch roller program** delivers **55% more** production than the usual 9-inch... and what painter doesn't want to shorten the work day? The Sherlock® 14-inch frame offers reliability and edge control like no knock-offs can. For larger jobs from walls to floors, think big... Wooster's 14-inch rollers are considerably better.



WOOSTER®

The Wooster Brush Company
800-392-7246
www.woosterbrush.com

PRO TIPS

TO GET THE MOST FROM **YOUR DECK**

Some powerwashers have detergent reservoirs and are good for applying lots of mild detergent. You can get more control using a simple garden sprayer, especially

with the stronger detergents. You'll get slow, even coverage that's easy to apply.

Let the detergent sit on the deck the manufacturer-recom-

mended period of time. This gives the detergent time to break down the stain. It's kind of like soaking dirty pans in the sink before scrubbing them. Use a synthetic bristle—never steel or wire—brush to agitate the solution. Keep a 5-gallon bucket of straight water handy to rinse the debris from the brush bristles as needed. Work up and down the length of the deck boards instead of across them, and don't apply more detergent than you can remove in the recommended period of time.

When it comes to verticals—anything from guardrail posts to privacy screens—check the



**Mother Nature knows
the best footings are
BIG AND ROUND.**

Adding on? Building a deck? Take a lesson from nature - round is better, stronger, smarter. Bigfoot Systems® pre-molded, ready-to-use footing forms have a well-established advantage - their shape.

Round footings are easier to level, take less concrete and can be installed in one day.

Bigfoot delivers the flexibility to build decks, porches, additions and many other applications regardless of height, complexity or weight requirements.

Choose the best, the strongest, the smartest.

**For stability you can trust
Build it with Bigfoot!**

BIGFOOT
SYSTEMS® The Original.

800-934-0393
www.bigfootsystems.com



ES

Canadian
Construction
Materials
Centre

ELIMINATE DENTS & DINGS

Shown here are two simple methods to protect the surface when maintaining your deck. When driving down loose nails, an old circular saw blade can provide a shield around the fastener to prevent damage from hammer blows.



When you need to pry out an old fastener, a scrap of aluminum flashing protects the wood-grain from being crushed by pressure from the hammer.



detergent you're working with for the recommend application direction. Some will recommend applying from the bottom up. Others, the top down. The reason for this is to prevent streaking, which once it's started, you can't stop it.

You won't need to do this every year but you'll want to keep an eye on your deck's finish and refinish it as needed. A simple test to see if it needs refinishing is to pour a cup of water on the deck surface. If water droplets form, your finish is still performing well. However, if the water sinks in quickly, it's probably time to reapply a sealant. If a treatment is needed, the best time of year is generally during the spring and fall when temperatures are more mild and consistent.

If you determine that you need to refinish your deck, it's always a good idea to remove any dirt or debris before applying a finish



As with all products, be sure to follow the manufacturer's guidelines for proper use and to make sure you're using the right product for your deck's wood species.



Even if your deck is several years old and showing signs of natural weathering, it's easy to restore the original color and beauty of the wood by applying a cleaning solution and wood brightener.



PRODECK
VINYL BALUSTRA SYSTEM "MADE IN AMERICA"

The Best Value for your Money!
Safety. Style. Performance

- Classic square balusters or Colonial turned spindles
- 36" & 42" rail heights
- Available in 3 popular colors: white, clay or sand
- Glass panels and many more accessories!
- Maintenance-free
- Limited lifetime warranty







DrySnap
Under Deck Balustrading System

Maximize Outdoor Living Space!

- Vinyl ceiling panels collect & drain water to provide dry space
- Provides a maintenance-free ceiling that covers the unsightly underside of a deck
- Easy snap-together installation
- 10-year limited warranty







800.347.2586
Amerimax.com



800.523.8852
BergerBP.com

PRO TIPS

TO GET THE MOST FROM **YOUR DECK**

(just follow the cleaning steps above). You'll want to allow several days for the deck to dry completely before refinishing.

Make these steps a routine part of your spring or fall clean up and you'll enjoy your deck for years to come. **EHT**

Editor's Note: Mark Clement is a tool and how-to expert, regular contributor to DIY magazines and TV, a contributing editor to Extreme How-to and spokesperson for the Softwood Lumber Board.

If you are powerwashing, always use as low a pressure as possible—between 500 to 600 psi. As a rule of thumb, try to never get closer than 12" to the wood deck.



Photo courtesy Softwood Lumber Board

Fast... Faster... Fastest! Made in America

Gauge and install fiber-cement siding up to 48% faster* with the Gecko Gauge.

Visit pactool.us/demo or scan this code with your mobile device to see the Gecko Gauge in-action today!

*Based on percentages based on test results of siding installation tasks as conducted and published by James Moore.

Celebrating Our 8th Year!

Special Pricing!

Free Gift With Every Purchase!

Gutster Demo Bar

Demolition Made So Easy... You Need To See It To Believe it

www.thegutster.com

Meet the HandiBot™

smart power tool

from ShopBot Tools

An innovative, portable power tool run from apps on smartphones, tablets or PCs. The Handibot smart tool brings push-button CNC technology to jobsites and DIY projects!



Now, instead of taking material to a stationary CNC machine, you just bring the Handibot to your material:

- Work directly on a table, the floor, the ceiling, the wall, wherever cutting, drilling, carving, or other machining is needed
- Get the precision, repeatability and power of robotics and digital control
- Armed with a simple software app for the job you need to do, it's ready to go to work with a squeeze of the "Start" button

WATCH the Handibot at work:
[www.handibot.com/
video_scrapbook.html](http://www.handibot.com/video_scrapbook.html)

LEARN MORE and check out
pricing at www.handibot.com



ShopBot
handibot™

Handibot™ is a trademark of ShopBot Tools, Inc.



DECK PRODUCT ROUNDUP

By Matt Weber

*It's soon to be deck-building season.
Here are some new
product highlights
to help outfit your outdoor retreat.*

EQUINOX XP LOUVERED ROOF

The Equinox XP Louvered Roof system is an adjustable roof that transforms from a solid covering to an open garden trellis or pergola style covering, providing light, ventilation and views of the sky. With the touch of a button, Equinox XP can give you complete flexibility of your light and weather control needs for any outdoor living area, year round.

The system is versatile enough to accommodate any architectural style, such as existing structures with gable or pitched roofs, bay windows, doors, or

an angled roof or walls. The Equinox XP can also be engineered for free-standing applications. The lightweight extruded aluminum louvers are durable and corrosion-resistant, which makes them ideal for both coastal and high elevation applications. The integrated gutter system keeps you dry and provides flexibility to be customized. Remote controls can be used to easily control multi-zone installations. Equinox XP is available in standard colors of white, tan and clay, with a 10-year warranty. Visit EquinoxRoof.com.

HIDDEN FASTENERS

Deck Building SOLUTIONS

*The answers for a long lasting,
more beautiful deck.*



The Hidden Link
HIDDEN DECK FASTENING SYSTEM



SHADOE TRACK
The Ultimate Deck Fastening System



www.suredrive.com
1-800-951-2222

DECK PRODUCT ROUNDUP

DECKING STONES

On your next decking project, turn scrap deck boards into stepping stones using Decking Stones from Deccessories. Designed for years of rugged outdoor wear and tear, Decking Stones can be used over tile, pavers, concrete, rocks or soil. The stones install in minutes to provide a direct match in color and material to the deck. The polypropylene frame securely holds the decking of your choice in place. The 1/8-in. spacing throughout the frame-work gives the Decking Stone the appearance of a traditional-ly spaced deck while adding a structural ribbing to stand off the ground. Visit www.decces-sories.com.

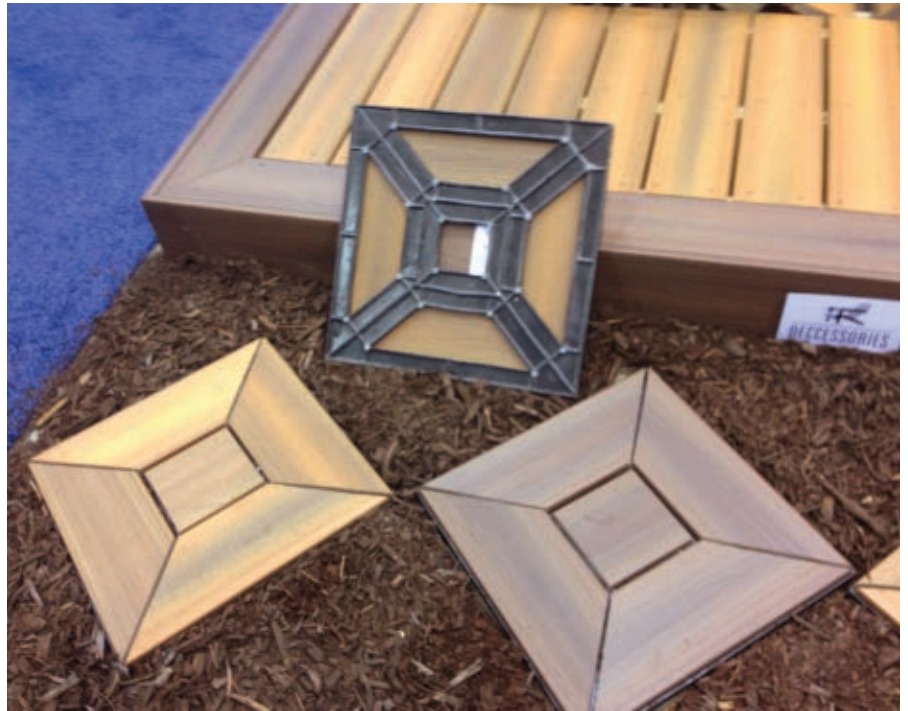

Best in Class BucketApe.com
Tile Installation Tool



Scan to Watch our video



- Always clean water
- No Hauling
- No Haze
- No Exhaustion

877-U-TILE-FAST

Sales@BucketApe.com

NU-WAL® RESTORATION SYSTEM

Make Walls and Ceilings Like New!

RESTORE CRACKED WALLS

- Cost effective
- One day application
- Remove no trim

SPECIFICATION CHEMICALS, INC.
www.nu-wal.com
 800-247-3932

Removable Magna Seal Soundproofing Window

Add a simple soundproof removable window pane.

REDUCE SOUND
in or out!

REDUCE HEAT
in or out!

win.alturl.com
 1-888-942-7723

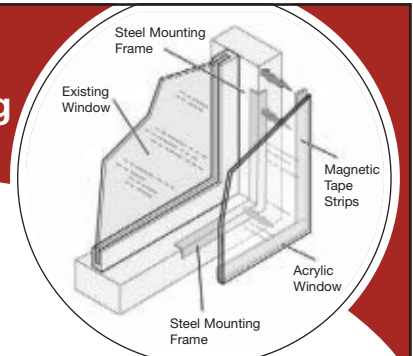

Super Soundproofing™
 The First Online Soundproofing Resource



THE HARDWOOD WRENCH

The Hardwood Wrench board-straightening tool gives deck workers the freedom of installing fasteners with ease, using a tool that cam-locks into place for true "one-man installation." With a pushing force of around 1,100 lbs., the Hardwood Wrench delivers up to 8x more bending power than other deck-board straightening tools. It works with single or double joists up to 3-1/2 inches wide, and with all types of decking, including pre-grooved or standard lumber, composites and PVC. The reversible handle accommodates multi-directional use for areas with limited space, from both left or right hand direction. Visit www.deckwise.com.

IT'S ALL ABOUT THE SELECTION!

Find an authorized dealer at screw-products.com

From assortment kits to zinc coated, and all points in between, we have the deepest Star Drives in today's industry. Visit our web site today to see our complete selection of Star Drive Fasteners as well as decking products such as DeckLok Advanced Lateral Anchor and The Ultimate Hidden Deck Fastener. We got ya covered!

VISIT OUR WEB SITE
FOR FREE CATALOG

CALL TOLL FREE:
888-888-9661



THE ULTIMATE FASTENERS



DECK PRODUCT ROUNDUP

THE GUTSTER

The Gutster demolition bar has been redesigned with an improved round steel handle and a solid cast head with extended neck, providing greater lifting and breaking power. More than a wrecking bar, the Gutster Demo-Bar is a complete demolition solution. The innovative Gutster design starts at the uniquely designed prying head. Split forks provide greater stability for heavier loads. The spacing straddles joints and studs for maximum leverage. Sharp points pierce the toughest materials effortlessly. Angled lift plates help ease the bar under materials to allow for faster prying. Conveniently built into the back of the head is a multi-nail puller. The angled bar is engineered to provide the most prying power with the least amount of stress and strain. Choose from three sizes with 40-, 48-, and 60-in. handles. Visit www.thegutster.com.

SUPERDECK SEMI-TRANSPARENT STAIN

Minimize deck maintenance and maximize the fun with a durable and beautiful finish. Superdeck's Semi-Transparent Stain features Carnauba from the "Tree of Life" to give unsurpassed durability. Carnauba blocks intense UV rays and holds up under extreme temperature changes. Superdeck Semi-Transparent Stain is formulated for any exterior wood surface including decks, fences, siding and furniture. Available in a spectacular 63-color palette, the stain's one-coat application will impart years of protection. High-quality oils keep the wood looking good, and premium pigments allow

the wood grain to show while blending multi-toned woods. The EHT staff used Superdeck's semi-trans cedar tone on a recent dock project that turned out beautifully. Visit www.superdeck.com.



METALCEILINGEXPRESS.COM

Tin Ceiling Tiles | Nail-up | Drop-in | Snap-Grid | Backsplash | Crown Moldings



Authentic Tin Ceiling Tiles | Factory Direct
32 Patterns | Hand Faux Finished Tiles
Fast Deliveries | Top Quality

1650 12th St East | Palmetto, FL 34221
MetalCeilingExpress.com | 941.723.2288





One of a Kind.

Beautiful. Strong. Durable. Unique NyloDeck combines the best of today's decking and makes it better. Made using 100 percent recycled carpet fiber, eco-friendly NyloDeck is the superior, yet affordable decking solution that sets the standard for a new generation of decking materials.

- Containing no wood or PVC, NyloDeck is impervious to water, mold, mildew and termites so it won't swell or rot.
- Looks like real wood; durable and rated twice as strong as other leading composites.
- Backed by extensive testing and a 25-Year Fade and Stain Warranty.
- Industry's best expansion and contraction rates.

NyloDeck will help you create the ideal, worry-free deck today and for years to come. Learn more at www.nylodeck.com



NyloDeck[®]
No Wood. No PVC. No Worries.

Find us on:     

NyloBoard - Made in GA, USA - 877-NYLO-909 (877-695-6909)



Desert
Spice



Saddle
Rose



Mountain
Mocha



Newport
White



Harbor
Gray

DECK PRODUCT ROUNDUP

TIMBERTECH EARTHWOOD EVOLUTIONS LEGACY COLLECTION

TimberTech is the first manufacturer to bring the popular hand-scraped look of indoor wood flooring to the outdoors. The new Earthwood Evolutions' line of capped composite decking now includes the Legacy Collection, with its earthy hardwood looks and rich undulating grains, to evoke the days of hand-hewn wood. The timeless style of the Legacy Collection can

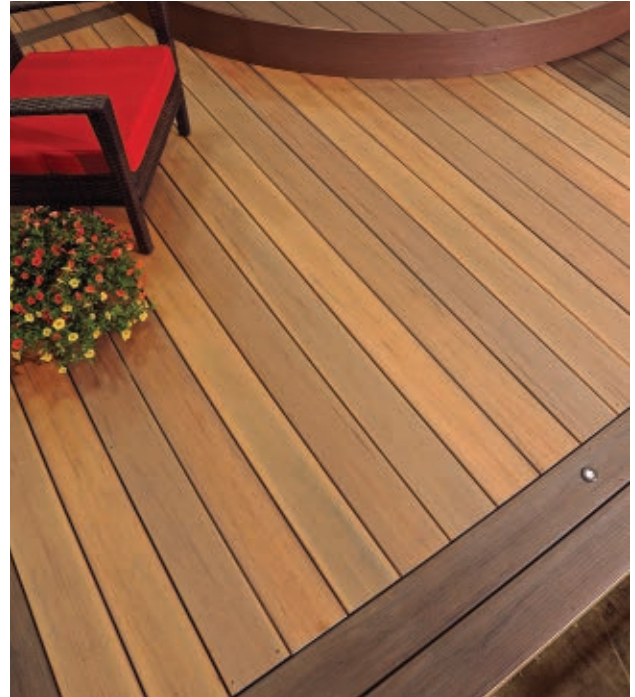

take your deck from rustic and relaxed to elegant and modern with any of the three distinctive, natural colors. Mocha is a deep, rich walnut color with a subtle, streaked variegation; Pecan is a warm reddish-brown color with earthy variegation to nicely complement brick or stone; and Tigerwood has a unique look that blends light and dark shades within the same board to more closely emulate the natural tones of Ipe, a tropical rainforest hardwood. As a member of the Earthwood Evolutions decking line, the Legacy Collection delivers strong aesthetics, along with scratch, stain and fade resistance that's backed by a 25-year fade and stain warranty. Earthwood Evolutions is the industry's only fully-capped decking line, with a protective polymer cap completely surrounding the proprietary composite core. Visit www.timbertech.com.

DECK2WALL SPACERS

Deck2wall Spacers help prevent rot from occurring at deck-ledger connections. The spacers separate the ledger from the supporting structure, providing a path



<p>14" DELUXE BANDSAW</p> <p>ANNIVERSARY EDITION</p> <p>CAST IRON WHEELS</p> <p>MADE IN TAIWAN</p>  <p>G0555LANV \$545.00 SALE \$525.00</p>	<p>17" 2 HP BANDSAW</p> <p>ANNIVERSARY EDITION</p> <p>MADE IN TAIWAN</p>  <p>G0513ANV \$895.00 SALE \$825.00</p>
<p>10" HYBRID TABLE SAW W/ RIVING KNIFE</p>  <p>G0715P ONLY \$795.00</p>	<p>10" WET GRINDER KIT</p> <p>ANNIVERSARY EDITION</p> <p>DESIGNED IN GERMANY</p>  <p>T10010ANV \$399.95 INTRODUCTORY \$159.95</p>
<p>3/4 HP SHAPER</p> <p>INCLUDES 1/4" & 1/2" ROUTER BIT ADAPTERS</p>  <p>G0510Z ONLY \$425.00</p>	<p>12" BABY DRUM SANDER</p> <p>MADE IN TAIWAN</p>  <p>G0459P \$595.00 SALE \$575.00</p>
<p>15" PLANER W/ MOBILE BASE</p> <p>3HP MOTOR</p>  <p>G0453P \$1125.00 ONLY \$1125.00</p>	<p>8" X 72" JOINTER W/ MOBILE BASE</p> <p>3HP MOTOR</p>  <p>G0656P \$825.00 ONLY \$825.00</p>

PLEASE VISIT GRIZZLY.COM FOR COMPLETE DETAILS & SPECIFICATIONS

FREE CATALOG

760 PAGES
HUGE SELECTION OF HIGH QUALITY MACHINES & TOOLS AT INCREDIBLE PRICES

VIEW VIDEOS AT grizzly.com

PRICING CODE

14EXTREME
MENTION THIS CODE WHEN PLACING YOUR ORDER
16131R

1-800-523-4777

grizzly.com

TECHNICAL SERVICE: 570-546-9663 FAX: 800-438-5901

SILENCE.

Squeak-Free Subfloors

Superior Holding Power

IBS Booth #C6847

SubLoc[®] SCRAIL[®]

for squeakless subfloors

The beauty of silence. Create squeakless subfloors with the superior holding power of SubLoc[®] SCRAIL[®] fasteners, available in two versions to silence squeaks large or small.

- Create virtually squeak-free floors
- SubLoc[®] for vastly improved holding power vs. ring shank nails
- SubLoc[®] PRO increases holding power by an additional 35 - 45%
- Quickly installed with a pneumatic nailer
- Twice as fast as collated screws
- Eight times faster than bulk screws



Upper thread adds clamping force, prevents micro-movement

No smooth section between threads

Special coating increases holding power vs. ring shank nails

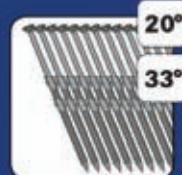

Scrailfasteners

Get professionally connected by visiting www.fascoamerica.com (scan the QR-Code with smartphone) or call 800-239-8665.

Master Distributor
FASCO
AMERICA

BECK Fastener Group, FASCO America, SCRAIL, The Nailer Fastener and SubLoc are registered trademarks of the BECK Fastener Group.

DECK PRODUCT ROUNDUP



for water and debris to flow harmlessly through the assembly, while promoting circulation and drying. The Deck2Wall Spacers have attachment holes to keep

spacers in perfect alignment for a fast and easy installation. The non-corrosive, one-piece design provides superior waterproofing. The Deck2Wall Spacers also provide a long-lasting solution for attaching shade structures, posts, stair stringers, landings, built-up beams or mechanical equipment. Made in the USA, the spacers are injection-molded, fiberglass-reinforced polypropylene, 5/8-in. thick with a 2-1/2-in. diameter and a 11/16-in. bolt hole. Recent testing from Washington State found that the Deck2Wall connections yielded higher design loads than direct connections. For example, 1/2-in. lags with ledger in direct contact with 1/2-in. OSB sheathing produced a design load of 451 lbs. vs. 1/2-in. lags with 5/8-in. Deck2Wall Spacers between the ledger and 5/8-in. sheathing for a design load of 801 lbs. Visit www.deck2wallspacer.com.

DECK FLASH BARRIER

NEW SUPER GRIP ADHESIVE!

PROTECT AND MAXIMIZE THE LIFE OF YOUR NEW DECK

PREVENTS WOOD ROT

SELF-ADHESIVE DECK FLASHING & ANTI-CORROSION BARRIER

Available in 3"x75' and 12"x25' Rolls

COFAIR PRODUCTS, INC.
800-333-6700 • www.cofair.com

I-LIGHTING

i-lighting focuses on maximizing the longevity and performance of LED lighting. The company's Easy Plug installation system features fixtures with Y-connectors, a regulated DC power supply and connection cables that simply plug together. No crimping, cutting or wire nutting are required. The system installs in half the time of standard indoor and outdoor systems. i-lighting has developed a complete line of



GOT MOLD?



TRY THE "BETTER-THAN-BLEACH" SOLUTION

Unlike bleach, Concrobium Mold Control® penetrates to the roots of mold – even on porous surfaces like wood and drywall.

The solution crushes mold spores as it dries, and leaves behind an invisible antimicrobial shield that protects against future mold growth.

Concrobium Mold Control eliminates and prevents mold with no bleach, no toxic chemicals and no VOCs. It's what the pros use.

Available at Home Improvement and Hardware Retailers.

www.concrobium.com | Connect with us:  



Concrobium Mold-Fighting System | Concrobium Mold Control® | Concrobium Mold Stain Eraser | Concrobium House & Deck Wash

DECK PRODUCT ROUNDUP

deck, rail, stair, landscape, masonry and under-cabinet lighting. i-lighting is truly LED lighting simplified. Learn more at www.ilightingLED.com.

ZAR CLEAR WOOD SEALER & NATURAL TONER BASE

United Gilsonite Laboratories (UGL) has an extensive line of



deck stains, clear sealers and deck cleaners—everything a contractor or DIY'er needs for various stages of deck care. Choose from ZAR Clear Wood Sealer, ZAR Solid Color Deck and Siding Stain, ZAR Semi-Transparent Deck & Siding Stain, and the newest product in the bunch, ZAR Clear Wood Sealer & Natural Toner Base. The new Clear Wood Sealer & Natural Toner Base is a latex base that comes with a 3-year warranty for decks and a 5-year warranty for siding. It's formulated to resist mildew growth with the incorporation of a non-hazardous biocide. This product has Green Wise certification and is winner of the *Popular Mechanics* Editor's Choice Award for product innovation. The new formula is perfect for accenting the natural beauty of wood decks, railings, posts, gazebos, fences, sheds and siding. Visit www.ugl.com.

Roll a REAL STONE surface right over your drab concrete!

Before



After



AS EASILY
AS PAINTING!

20 YEARS PROVEN PERFORMANCE



Transform your home in ONE WEEKEND

- **REAL STONE OVERLAY** - Not a faux finish
- Excellent on concrete, wood, tile & linoleum
- Resistant to water, salt, chemicals, stains & UV
- Water-based, odorless, low VOC and Non-Toxic

Featured weekly on the
Gary Sullivan National Home Improvement Radio Show



Get the complete high performance product line – at super-low factory direct pricing!



LEARN MORE AT...

WWW.DAICHCOATINGS.COM

Elastilon[®]

Self-Adhesive Hardwood Flooring Installation System

70 year
Limited Warranty



Now You Can Install Solid
Hardwood Floors In Any Room.
**NO NAILS, NO GLUE.
NO MESS.**

Elastilon is the patented self adhesive hardwood flooring installation system that is revolutionizing the way floors are

being installed around the world. The Elastilon Strong system **replaces nails, nailing guns, compressors, messy adhesives, specialized adhesive trowels and chemical cleaners** with one simple installation tool — a utility knife. **Installation times are cut in half** and installations are so simple that even a home handyman can do it.

Elastilon allows almost any species and thickness of hardwood flooring up to 3/4" thick to be installed over almost any surface, be it wood, old vinyl tiles, linoleum, ceramic tiles and, with the proper installation, directly over **concrete** — above, on or even below grade. No fuss, no mess!

Once your floor is installed with Elastilon there is a permanent elastic bond that allows for the natural expansion and contraction of your floor while always helping to reduce gapping, cupping and buckling. The Elastilon membrane reduces both airborne and impact sound transmission, increase underfoot comfort, allows for installations over in floor heating and can be walked on immediately following installation.



Want to learn more about Elastilon and save money at the same time? Visit us at www.elastilonusa.com/coupon for complete details on becoming an Elastilon Expert and find out how you can receive up to a **\$500 cash back rebate** on your first purchase.



Elastilon[®]USA

TOLL-FREE (877) 526-9663 www.elastilonusa.com

DECK PRODUCT ROUNDUP

780 in.-lbs. of impact-energy at 100 PSI, the FramePRO drives 34-degree offset round-head and clipped-head, paper-tape fasteners ranging from 2 to 3-1/4 in. long into any substrate,

including engineered lumber. With its durable external aluminum housing and internal metal components (high-strength steel driver blade and aluminum firing valve), the FramePRO is built to handle



the rugged demands of framing, sheathing, truss building, sub-flooring and deck building in any climate. The tool features a thumbwheel adjustable depth-of-drive and a patented tool-free selectable trigger so users can easily switch between bump-fire and single shot modes. Visit www.senco.com.

DECK FLASH BARRIER

Cofair Products introduces Deck Flash Barrier, a self-adhesive deck, post and ledger board flashing. When applied to the tops of joists, around posts and over ledger boards, Deck Flash Barrier creates a waterproof membrane that prevents wood rot caused by water coming in contact with wood. Deck Flash Barrier's new super-grip adhesive can be installed down to 25° F and self-seals around screws, blocking the primary pathway for water infiltration into the decking support lumber. Deck Flash Barrier is available in both 3 in. by 75-ft. and 12-in. by 25-ft. rolls. Visit www.cofair.com. **EHT**



Re-roofing over shingles? Easy!

Installing a new roof provides a perfect opportunity to elevate the look of a home in a dramatic way. ONDUVILLA® makes re-roofing projects quick and easy. You can install the product directly over two layers of shingles. It's easy to cut and install with basic tools, it's lightweight and flexible, and requires no extensive training. ONDUVILLA® has the distinctive appearance of traditional Mediterranean tile and comes in five designer colors sure to make any homeowner proud.



For more information, email us at info@Ondura.com, call 800.777.7663, or visit www.OnduvillaUSA.com.

ONDUVILLA®

 Find us on Facebook by searching 'Ondura'

Mowing

GET WORK DONE.



There is no comparison between a Zero Turn Mower and any other powered mower when it comes to getting work done quick and efficiently. A Land Pride Zero Turn Mower can cut square corners, zip around trees, and increase overall productivity on your farm, in your yard or at your business.

Get mowing work done... with Land Pride's Zero Turn Mowers!

Over 280 Products to Fit Your Lifestyle...



A Division of
Great Plains Mfg., Inc.
Salina, Kansas
www.landpride.com



Lp CONSISTENTLY LEADING THE WAY...

PLANNING A BATH



ROOM REMODEL

By Rob Robillard

Many people do not know how to plan a bathroom remodel. As a restoration contractor I've seen many situations where homeowners have spent thousands of dollars in restorations that commence with no planning, no idea of a budget and with unrealistic expectations. Whether you're a contractor or a homeowner doing the work, the planning process is the same. The premise of this article is to explain the process and help you develop a detailed scope of work that you can communicate in clear and concise terms.

EDUCATE YOURSELF

Ask questions, look at other projects and research your products and materials before starting. There is a ton of "product"

at supply stores and on the internet to compare and contrast. Consider using a checklist for manufacturers of fixtures, appliances, hardware, etc. I always suggest using products from quality manufacturers with a proven track record.

This is also the time to reach out for help on your design, if needed. For example, if you're moving walls, do you need an architect to prepare detailed drawings? Having a drawing helps folks visualize the final product.

For the contractor, the goal of detailed drawings is to work out spatial issues, to anticipate design issues and to eliminate surprises. This also provides a picture for you and the contractor of what the finished product will look like.

Decisions are better streamlined with a drawing, which helps prevent subcontractor

*Preparation, coordination and communication are
your keys to success.*

PLANNING A BATHROOM REMODEL

tors and workers from being hit with unexpected decisions or products requiring additional labor and/or materials to install.

Plan Your Remodel before Starting

Having a plan doesn't mean picking out tile and paint colors and then smashing out the walls.

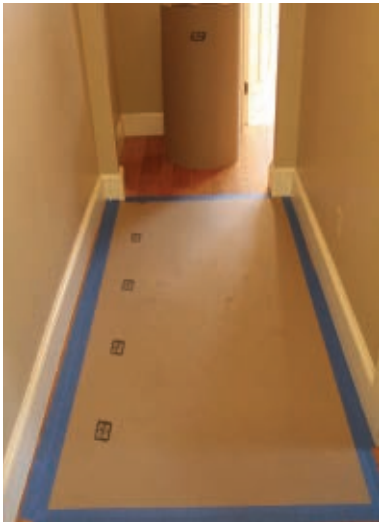

Not only is bathroom remodeling a messy job, but demolition debris that is tracked through the house can damage finished surfaces. Plan in advance to manage dust and debris. Contractor paper taped along the edges can protect hardwood floors.



A canvas drop cloth makes a flexible and reusable protective cover for stairs surfaced with wood or carpet.



Determine a comprehensive plan to complete the project prior to starting demolition.

It means thinking through the whole process, writing it down and trying to anticipate problems, time sinks and construction roadblocks.

Prior to starting the project, take the time and effort to thoroughly inspect the home and come up with a plan of approach. Hire an architect or general contractor to inspect and work up a scope of work. Plan so that one phase of the project transitions logically to the "next step."

Many people assume that the

contractor will make logical decisions in scheduling and planning the project. The fact is that a bathroom project involves numerous different subcontractors, and every one of them has their own schedule and agenda. Getting these folks to physically see the site, submit a proposal and commit to a schedule can be quite a task, but is imperative to do.

Your bathroom is about to become a construction area. Discuss and establish ground rules with your contractor,

COMING SOON!

Faster, Thinner Floor Warming



Schluter®-DITRA-HEAT

Electric floor warming system with integrated uncoupling

Floor warming systems have become very popular. Heating tiled floors increases the need for uncoupling to prevent cracked tiles and grout. Use Schluter®-DITRA-HEAT to get both – warm floors and uncoupling – in a single layer.

- Heating and uncoupling in a single layer
- No self-levelers required to encapsulate heating cables (no need to wait for curing)
- Place the heating cables exactly where they are needed
- Combines the flexibility of loose cable with the ease of installation of a mat system
- 120V and 240V options



www.schluter.com | 800-472-4588

Connect with us!



PLANNING A BATHROOM REMODEL

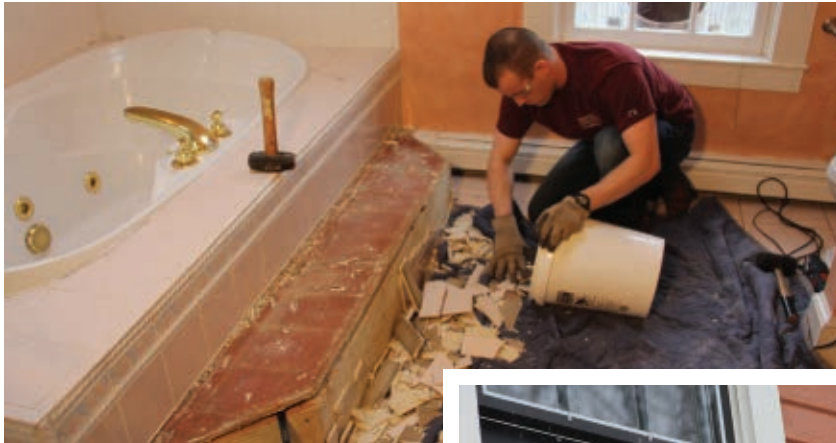

Bathroom demolition creates a substantial amount of garbage in the form broken drywall and shards of tile. Plan a way to dispose of the material in an orderly fashion.

Second-story remodels can utilize a garbage chute at the bathroom window.



such as where lumber and materials will be stored, jobsite clean-up, dumpster location, use of the toilet and parking of vehicles. Also, discuss debris removal and dust containment.

A clean job eliminates safety hazards and helps to keep the clients at ease; it also presents a more professional appearance for the contractor.

Murphy's Law: Throw in a Monkey Wrench!

When planning a bathroom remodel, prepare yourself for hidden conditions that will add more expense, more time, more disruption and problems than you planned on. Surprises of one kind or another are common and even "predictable" when remodeling a bathroom. The key is to plan for that extra time beforehand to avoid stress.

NUSTAIR®

STAIR REFACING SYSTEM

SIMPLE SOLUTION

Fits right over your old stair nosing

Save 50% of your MONEY!



- 5/8" and 3/8" Tread thickness available for the perfect refacing solution!
- Use 3/8" for 1st tread when no new flooring is being added.

www.NuSTAIR.com
www.idealstairparts.com



Solve IAQ and Comfort Problems



- XCHANGER™ Reversible Ventilation Fans and UnderAire™ Crawl Space Fans
- AireShare™ Room-to-Room or Level-to-Level Transfer Fans
- Balance Booster™ Reversible Transfer Fan
- Radon VAC™ Side Wall Radon Mitigation Systems
- Sure Dry™ Shower Drying Systems
- Clothes Dryer Duct Boosters®
- Auto-Draft® Chimney Top Fans
- Duct Booster® Standard & High Performance fans

Tjernlund Products
 800-255-4208 • tjernlund.com

Visit Us at IBS Show Booth 52023



The garbage chute channels demolition debris to a trash can or dumpster on the ground.

Many people have no clue about the “hidden costs” of remodeling, and a lot of contractors do not advise their clients of them. Hidden conditions include

things like repairing surprise termite damage, improper wiring, outdated plumbing, abating asbestos or repairing foundation damage. Any or all of these can stop a remodel process mid-point and add time and money to the project.

Plan for these conditions by allocating 10 to 20 percent of your budget to address them. Whatever your project's estimate, I promise that you will most likely spend additional money on hidden conditions.

PREPARE YOUR BUDGET

Proceeding with no budget is just plain stupid unless you have access to limitless cash. Define a scope of work with your contractor to arrive at a professional, accurate and performable

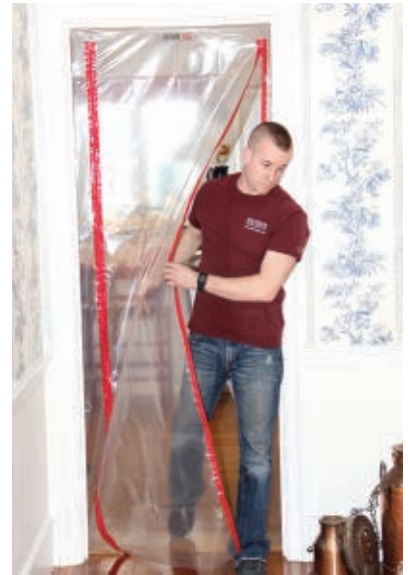

Sealing the doorways of the construction site with a plastic will inhibit dust from circulating throughout the rest of the home.

NEW

Introducing Starrett, Starrett Exact and Starrett Exact Plus

Measure ~~twice~~...

once

What company always measures up?



See the entire new hand tool line!
www.starrett.com



starrett.com

Starrett®

Innovation Rules

PLANNING A BATHROOM REMODEL

budget. Unrealistic budgets are common among homeowners that have not researched costs or don't understand what is involved in a bathroom remodel.

Many people try to get a contractor to make an unrealistic budget a reality, and the end result is that corners get cut. At a minimum you will need a well-detailed proposal for your bathroom remodel.

In my opinion, vague proposals and plans encourage low bidding and invite many hidden and sometimes costly "extras" to be tacked onto the job later. Not having a detailed plan also means that two different contractors bidding on the same project will never arrive at the same conclusions and will always make assumptions to fill missing information—resulting in an "apples to oranges" comparison.

Not having a well detailed plan

means the contractors bid only on what they "gleaned" from your verbal communication. Some unprofessional contractors will take this as an opportunity bid low and hit you later with extra costs.

PROJECT COORDINATION

Coordination is commonly the job of a general contractor or architect. Without a schedule and proper coordination the individual tradespeople are



A bathroom project involves numerous different subcontractors, and every one of them has their own schedule and agenda. It's imperative for these folks to physically see the site, submit a proposal and commit to a schedule.

Woodworker's Hardware

10% Online Discount in March
Use code ETHMAR



Knobs & Pulls

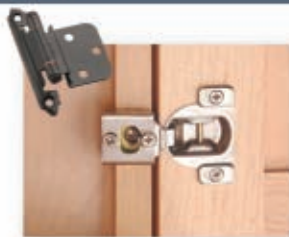

Hinges
Decorative & Concealed



Drawer Slides
Undermount & Side Mount



Request a
FREE catalog!

Kitchen Organizers



Bottom Mount Wood Waste Containers



Heavy Duty Mixer Lift

Tools & Supplies



Compound Mitre Saw Blades



Sanding Discs



Titebond Wood Glue

Also stocking:

- Lazy Susans
- Fasteners
- Locks
- Lighting
- and much more...



Woodworker's Hardware

woodworkershardware.com
1-800-383-0130



www.betterwayac.com

INGRAM'S
WATER & AIR EQUIPMENT

**NOW
OFFERING
COMPLETE
SOLAR
KITS!**

Guaranteed Lowest Prices!



HEATING & AIR CONDITIONING:

Air Conditioners, Geothermal Heat Pumps, Split System Heat Pumps and more!

WATER EQUIPMENT:

Water Softeners, Water Coolers, Faucet Mount Filters and more!

AIR PURIFICATION:

Electronic Air Cleaner, Low Micron Media Filter, Humidifiers, Portable Air Units and more!

INGRAM'S OFFERS:

FRIENDLY SERVICE.

We are a friendly, family-owned business that enjoys getting to know our customers. Your concerns have our utmost attention.

LOWEST OUT THE DOOR PRICE.

We guarantee to have the lowest out the door price. This is after shipping cost, special handling fees, insurance, and etc.

FAST SHIPPING.

All HVAC shipments are easily monitored from our door to yours. We strive to save you additional money on freight cost, call us for the lowest available shipping quote.

Save Up To \$500 With
Our Industry Exclusive

PRESSPLAY
REWARDS

Call us **1-800-360-1569**

Visit us **BetterwayAC.com**

PLANNING A BATHROOM REMODEL

segregated, disjointed and will not communicate.

For example: Adding a simple whirlpool tub to a bathroom remodel also means that you first need to install a 20-amp

circuit. This involves installing a wire from the main electrical service to that tub—a step that can be easily overlooked by a homeowner or contractor if coordination and communication does not occur



Plan so that one phase of the project transitions logically to the "next step."



Discuss with your contractor such issues as smoking policy, playing of music, music volume, use of profanity, and private or restricted areas.

SHELVES THAT SLIDE

- Custom Made for Your Cabinets
- Kitchens • Pantry • Bathrooms
- Limited Lifetime Warranty
- Baltic Birch Construction
- 100 Pound Capacity

1-800-598-7390
www.shelvesthatsslide.com

Order On-Line

**Custom pull out shelves
and Kitchen cabinet accessories**



Call or email for a free catalog

between the plumber and electrician. Everyone needs to work together.

Part of this coordination is to bring in your sub-contractors early to look at the space and your fixture selection schematics and installation requirements.

GATHER YOUR FIXTURES

A bathroom remodel requires fixtures, cabinets and counters. Prior to starting your bathroom remodel, take the time to identify manufacturers and make your selections early.

Early selection ensures that your contractors know what you want installed and can price accurately. It also gives them



1. **Oneliner**
Water Proofing

2. Pre Pitch

3. Kirb Perfect

4. Quick Pitch

5. CertainTeed™
Vapor Barrier

6. Concrete wall Board

7. Bench Seats
& Shelves

8. Soap & Shampoo
Niche

9. Positive Weep

10. Drains

11. Curb Sills Marble

12. Shower Heat

PLANNING A BATHROOM REMODEL

the opportunity to work out any structural, electrical or plumbing issues, and to determine if that fixture is going to work in the bath space or not.

Get your fixtures ordered and on

site prior to starting the job. I've seen many times a special-order toilet or tub arrive damaged or lost in transit, and the entire project comes to a stop for three weeks while we waited for another one.

The best practice is to get the fixtures on site where they can be inspected and stored for the project.

By making your plumbing fixture, recessed mirrors and lighting decisions early, you're more likely to stay on schedule, save time and money.

COMMUNICATION IS CRITICAL

Once you start your bathroom project it is important to maintain regular communication with your contractor. That usually means a daily meeting or phone call. Avoid emails, as they can be misleading and not contain enough information. It's best to meet in person to discuss and then summarize that meeting in an email.

Good communication will allow you to handle unexpected issues quickly, make timely decisions and move forward.

SUBCONTRACTORS

Good contractors hire good subcontractors.

You should have a discussion with your contractor about subcontractor ground rules while at the work site. Discuss issues such as a smoking policy, playing of music, music volume, use of profanity and private or restricted areas.

One thing a lot of folks overlook is that subcontractors are specialists in their field and can offer a lot of industry training and experience to resolve issues and solve problems. Make sure you utilize their expertise.

BIG PICTURE

Proper planning prevents unnecessary roadblocks and helps you realize your vision by defining your space. Realistic schedules need to be produced. A proper sequence of events should be spelled out clearly so that the necessary materials are

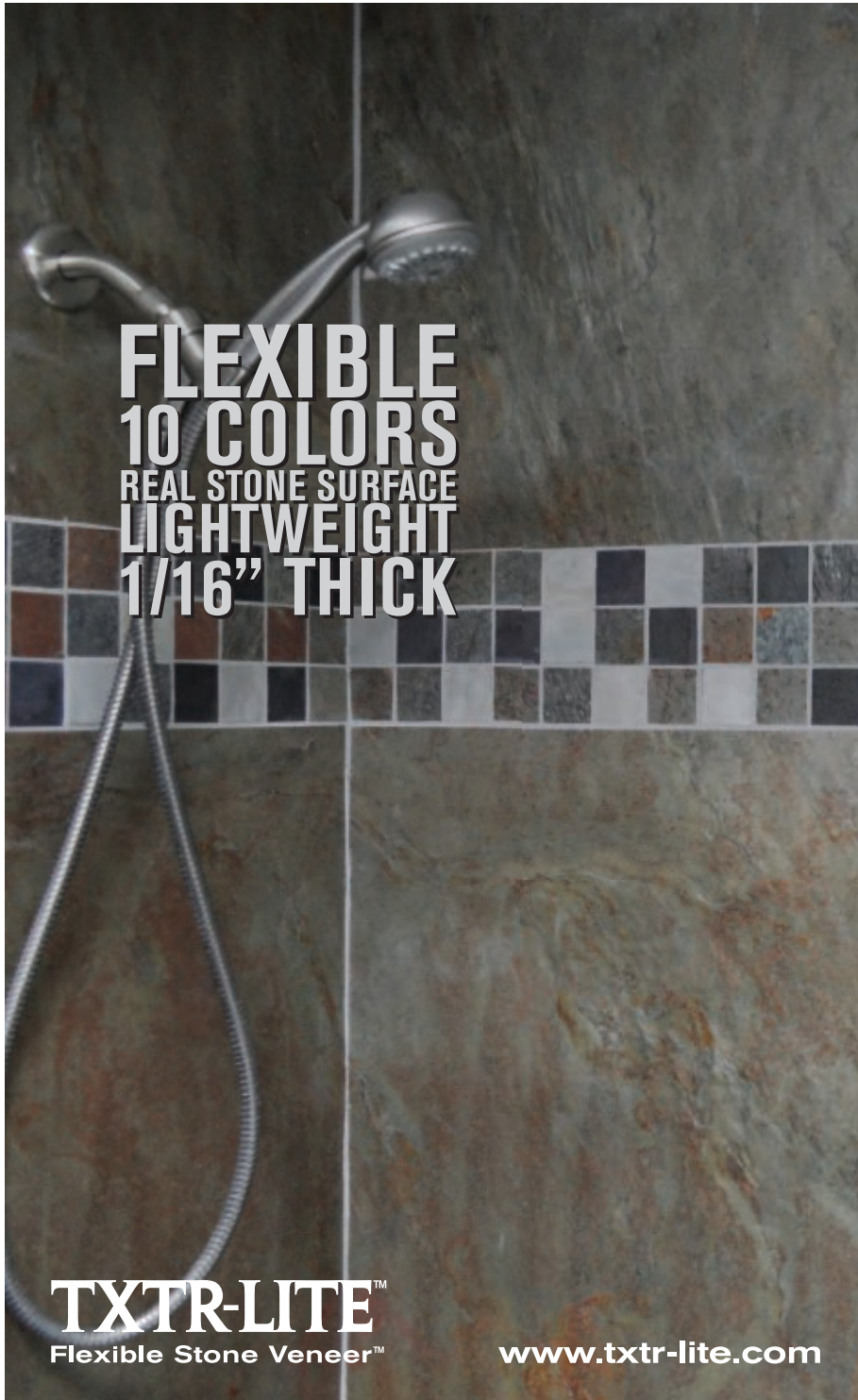

**FLEXIBLE
10 COLORS
REAL STONE SURFACE
LIGHTWEIGHT
1/16" THICK**

TXTR-LITE™
Flexible Stone Veneer™

www.txtr-lite.com

Put Our Tools to the Test



Members of our Wooster Painters' Program are the first to know about applicators that shape the future of the industry. Even after being conceived in our engineering department and examined in our lab, if a brush or roller can't stand up to the demands of professionals, it won't wear the Wooster name! Join the Wooster Painters' Program and you'll get the opportunity to test new tools, receive our quarterly newsletter, and earn Wooster premiums like hats, T-shirts, camp chairs and more.

Become a Wooster Painter. Sign up for FREE!
www.woosterbrush.com/WoosterPainterSignUp

The Wooster Brush Company • 800-392-7246

WOOSTER
Painter

PLANNING A BATHROOM REMODEL

on hand at the right time. In other words, don't gut the bathroom until the plumbing fixtures and vanity cabinet are on site and ready to install. By being informed

and expecting the unexpected, you can minimize stress, costly errors and maximize your budget to arrive at a spectacular bath remodel project. **EHT**

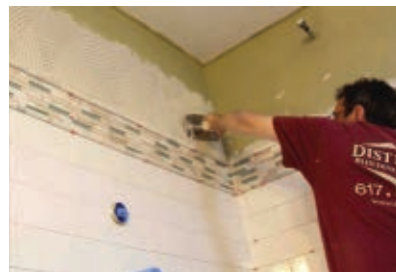

Proper planning, coordination and communication will help your project run smoothly and better prepare you for the surprise challenges that come with every bathroom remodel.

More than 30 years experience in the spray foam industry.

Versi-Foam
systems

**Low-Pressure
Spray Foam
Insulation Kits**

MADE IN USA

RHH Foam Systems, Inc.
Phone: 800-657-0702
Email: sales@rhhfoamsystems.com
Web: www.rhhfoamsystems.com

UNIQUE, FLEXIBLE STONE VENEER

TXTR-LITE is a natural light-weight flexible stone veneer with unlimited application possibilities. Each sheet is different because every piece consists of a thin layer of real stone, and no two stones are exactly the same. The colorful veneers are made from stone or slate slabs from which only the top layer was used. TXTR-LITE is backed by a polymer composite, which gives the sheets their flexibility and strength while keeping the weight to a minimum. TXTR-LITE is also waterproof once installed and effectively creates a tough moisture barrier. When Remodeling with TXTR-LITE, it's easy to install over existing tiles for bathroom and kitchen remodels. This means you don't have to remove existing tile while remodeling and have no demolition materials to haul away. Typical thickness is 1mm to 2mm and can be easily shipped by FedEx Ground. Discounts are available on orders for jobs over 500 square feet. Learn more at www.txtr-lite.com.

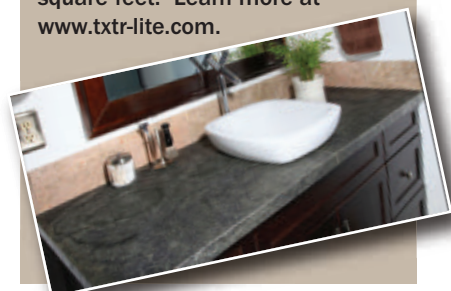

PROFLEX

Membranes

Proflex Elastomeric self-bonding membranes

are composite underlayments consisting of petroleum and rubber based materials laminated to a high-strength reinforcing fabric. The product has excellent strength and elongation properties designed to be used in a variety of building and remodeling applications. Proflex membranes provide a variety of benefits and protection in the following areas:

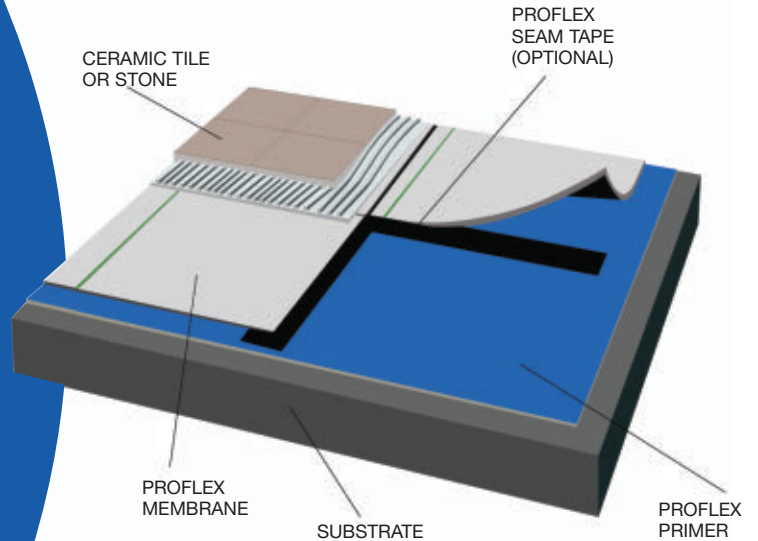

Crack-Isolation:

Proflex membranes will bridge cracks and control joints up to 3/8", eliminating the transfer of cracks to the finish flooring surface.

Moisture Vapor:

Proflex membranes, installed in a specific manor, will provide a barrier against the transmission of moisture vapor from a substrate to a finished flooring surface.

Waterproofing:

Specific Proflex membranes may be used in some waterproofing applications (contact technical support for additional information).

Sound Reduction:

Proflex membranes provide sound abatement properties. The specific sound reduction will be unique to each type of Proflex products. Refer to individual data sheets for specific sound insulation performance.

877-PROFLEX (877-577-6453)

www.proflex.us



Super Simple TV Shelf

Here's an easy-to-make accessory shelf for a wall-mounted television.



By Matt Weber

If you have a free afternoon, a couple of shelf brackets and some spare plywood, you can organize a wall-mounted TV the way we did.

Although ready-made TV mounting hardware nicely supports a flat-screen on a wall, such systems do not accommodate a satellite receiver or Blu-ray player. After installing a new wall-mounted flat screen, a handful of cables dangled down the wall from the TV to the top of a dresser, where they were connected to the accessory electronics. It was a disorganized mess, so I built a shelf to streamline the look.

This is a simple project that requires only a few critical measurements. Measure the electronics you need to hold, making sure to

leave ample room for the cords or cables that plug into the rear of the console. Also, measure the width of the television. The size of your shelf should strike a balance between a large enough size to support the TV accessories while small enough to look proportional to the TV screen.

I cut the shelf from 3/4-in. oak plywood. To hide the unfinished edge of the plywood, I wrapped the front and sides of my shelf with solid oak edging. I ripped the oak strip to 1/4-in. thick, and used its 1x (3/4-in.) height to completely conceal the plywood edge. Note: Remember to account for the thickness of the edging when determining your shelf size.

The shelf was supported by metal shelf brackets mounted into

the wall studs with heavy-duty screws. Since the shelf was to be mounted over a dresser, we chose brackets with an arched, concave design to retain as much under-shelf dresser space as possible.

The power outlet and satellite connection were located at the floor level and behind the dresser. To manage the wires, I drilled into the drywall to route the wires behind the drywall and through the stud cavity to a second access hole near the power outlet.

If you decide to route the wires through the wall, make sure to check the wall with a stud finder to ensure there is no between-the-stud blocking in the wall or other obstruction that would interfere with routing the wires. If you are unable to hide the wires inside the wall, an alternative solution is to install wire molding, which conceals the wires in a plastic channel. You can then paint the wire molding to match the wall color.

STEP BY STEP



The jumbled wires and cumbersome TV accessories were an unsightly mess in this bedroom.

Hi-Velocity Systems™

www.hi-velocity.com

Small Duct High Velocity Heating, Cooling and Indoor Air Quality Systems

Many Attractive
Vent Plate
Finishes Available



Small Diameter Flexible Duct fits
in confined areas with no major
remodelling



Ideal for Residential, Multi-family,
Retrofit and Commercial Applications

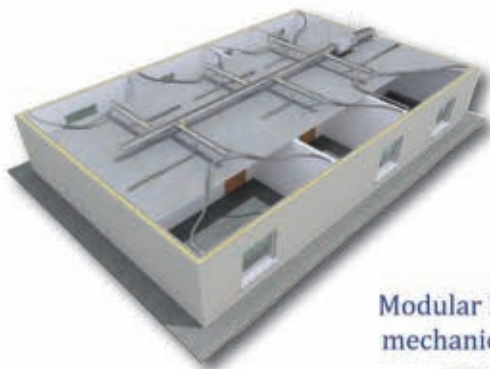

Modular Fan Coil Units fit easily in
mechanical rooms, closets, attics,
crawlspaces, anywhere!



Hi-Velocity Systems™ are engineered to deliver quiet comfort, superior performance and energy efficiency.

*Energy Saving Products Ltd.
Proudly Family-Owned since 1983
Call us today 1-888-652-2219*

QUICK FIX

To solve the problem, the shelf should be deep enough for the largest of accessories, plus the necessary clearance for cords connected at the rear.

The shelf should be wide enough for the accessories without looking out of proportion to the TV set.

Trim the shelf stock to size, accounting for the extra 1/4" edging at the sides and front.



Locate the studs on the wall. Center the shelf over the studs and transfer those measurements to the underside of the shelf to mark the shelf brackets.

THE BEST PORTABLE TOOL STORAGE AVAILABLE



K-2

**Water
Resistant**

Lockable

**Rolls
Anywhere**

Stop Lifting and Start Rolling!

- High volume tool storage and transport
- Takes the work out of carrying tools and parts
- Double wall polyethylene durability
- Store - Lock - & Roll tools and supplies to the job **IN ONE TRIP!**



K-1

1-800-KADDIES (523-3437)

WWW.KADDIES.COM

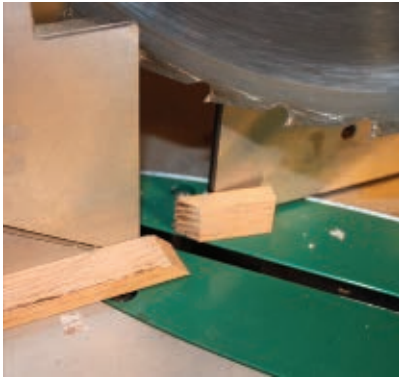

Trim the edging to size, cutting 45-deg. miters at the corners.



Sand the shelf in the direction of the wood grain with progressively finer abrasive to 220-grit.



Test-fit the edging.



The edging was installed with a combination of wood glue and finish nails, with holes predrilled for the nails.

Use paintable wood putty to fill all joints and nail holes.

**Keeps Paint Out.
Keeps Lines Sharp.®**

FrogTape® is the only painter's tape treated with PaintBlock® Technology. PaintBlock® forms a micro-barrier that seals the edges of the tape, preventing paint bleed. Visit FrogTape.com to see PaintBlock in action, get painting tips and more!

FrogTape.com
877-FROGTAPE
(376-4827)

PATENTED
FROGTAPE
Keeps Paint Out. Keeps Lines Sharp.®

© ShurTech Brands, LLC. 2015/52281

QUICK FIX

Dust the shelf with a tack cloth and apply wood stain. I chose a gel stain because it doesn't run and is easy to work with.

Once dry, apply two or three coats of polyurethane, lightly scuff-sanding between coats.

Screw on the shelf brackets with 1/2" wood screws.



Just above the surface of the shelf location, where the hole would be concealed by the satellite receiver, I used a 1-3/4-in. hole saw to drill access for the cables. I made a second hole at the floor near a power outlet.

The Professional's Choice—Worldwide

Tools | Installation Products | Floor Machines | Accessories

Tools⁴Flooring

The Professional's Choice—Worldwide



Selection,
Service & Price
on Brand
Name Quality
Products.

- Fast & easy online ordering
- FREE shipping on qualifying orders
- All major credit cards accepted
- Financing available

Buy Online or Call
866.634.1189

Bullet Tools, Grain, Duo-Fast, Gundlach, Husqvarna, Johnsonite, Leister, National Equipment, Orcon, Personna, Powermail, Roberts/QEP, Raimondi, Rubi, Sinclair Equipment, Taylor Tools, Turbo, Wolff, and many more...



www.tools4flooring.com



I protected the edges of the access holes with plastic computer grommets.



Center the shelf beneath the TV. Fasten one shelf bracket into a stud, then level the shelf.



Once level, drive home the second screw. I used 2-1/2" R4 construction screws from GRK Fasteners to sink solidly into the framing.

All-in-One Dust Collection for the Small Shop!

Regular shop vacuums don't stand a chance.



The Dust Cobra®

- ▶ 3x the power of most shop vacuums.
- ▶ Internal filter cleaner - no filter removal, no mess!
- ▶ Full unit HEPA certification - Meets EPA requirements including lead.
- ▶ Approx. 4' 4" tall and 20"x 20" with optional Mobile Cart.
- ▶ Built in the USA to last a lifetime.



Both are proudly Made in the USA



Dust Deputy®

Captures 99% of the dust before it reaches your vacuums' filter.

- ▶ Retrofits to any shop vacuum.
- ▶ Pays for itself in filter replacement costs alone!
- ▶ Helps maintain suction.
- ▶ Easy to empty bucket.

Deluxe Dust Deputy® - \$89.00

Call Today for **FREE** Catalog!

1.800.732.4065

www.oneida-air.com



Dust Collection Since 1993.

QUICK FIX



I masked the fastener heads using paper (with a dime-sized hole cut in the center), and spray-painted the heads black to match the brackets.

Finish up by using fish tape to route the cables from the shelf, through the wall, and out of the lower access hole where they plug into the outlet. **EHT**



BECAUSE IT'S EASY BEING **GREEN**

STEP
warmfloor®

THE ORIGINAL

RADIANT HEAT.
LOW-VOLTAGE (24V).
ENDLESS POSSIBILITIES.

WWW.WARMFLOOR.COM 877-STEP-TEC

Flexi-Tile HomeStyle Natural Stone Tile

Flexi-Tile HomeStyle Stone Series:



The Perfection Floor Tile HomeStyle Stone Series Tiles are flexible, PVC Hidden Interlocking Tiles. We have achieved the look of real stone, while offering comfort, style and durability.

Our tile has a texture and feel of rubber, but is made from PVC.

Easy Quick Simple Do It Yourself Install, No special tools required! Can be installed over old, uneven or contaminated sub-floors, while providing ergonomic benefits such as warmth and comfort under foot, and superior **sound absorption** qualities that reduce noise levels. Can be used immediately, no down time.

Large selection of standard color styles and patterns, easy to uplift and relay. Durability: 10 Year Warranty, Made In USA!

—Use anywhere a great floor is needed.



- Basements
- Home Gyms
- Play Rooms
- Living Room
- Game Room
- Dens
- Offices
- Patios
- Mudrooms
- Daycare
- Schools
- Military
- Retail
- Nursing Homes
- Offices
- Heavy Traffic

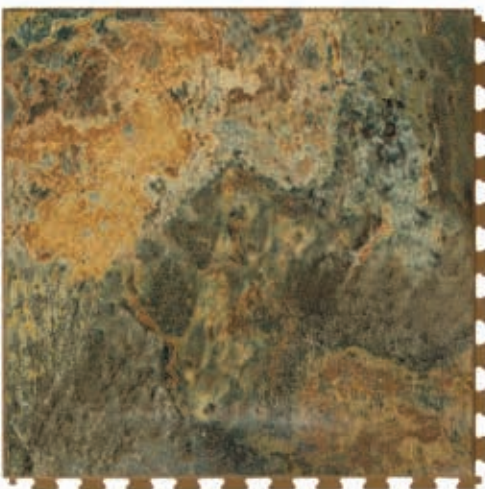

Natural Stone Colors: Imperial Gold, Sandstone, Fieldstone, White Marble, Black Marble, Atlantic Slate, New England Slate, Sedona Slate, Cork, Walnut Wood

WWW.FLEXITILES.COM or WWW.PERFECTIONFLOORTILES.COM

Many other product types. *For Free Samples, Pricing and Product Details* please visit our web site.

Elite Xpressions LLC Direct: 361-906-0863 | Toll Free: 866-556-6324



HOT PRODUCTS

ELASTILON

Elastilon is a patented self-adhesive hardwood flooring installation system that can replace nails, nailing guns, compressors, messy adhesives, specialized adhesive trowels and chemical cleaners with one simple installation tool—a utility knife. The system can cut installation time in half. Elastilon allows almost any species and thickness of hardwood flooring up to 3/4-in. thick to be installed over almost any surface, be it wood, old vinyl tiles, linoleum, ceramic tiles and, with the proper installation, directly over concrete—above, on or even below grade. Once your floor is installed with Elastilon there is a permanent elastic bond that allows for the natural expansion and contraction of your floor while always helping to reduce gapping, cupping and buckling. The Elastilon membrane reduces both airborne and impact sound transmission, increases underfoot comfort, allows for installations over in-floor heating and can be walked on immediately following installation. Visit www.elatilonusa.com.



PVC SNAPP SCREEN SYSTEM

Connecticut Screen Works now offers a flexible PVC version of its Snapp Screen System. The Snapp system can be mounted to any surface and to openings that aren't square, plumb, or even level. Now, with the addition of the PVC extrusion, there is basically no limit to the applications or shapes possible. No special tools are required for installation, and a minimally skilled DIY'er will be able to achieve professional results with general effort. Circles, arches, eyebrows, etc., can all be screened with relative ease. In most cases, the new PVC extrusion can be molded right into the shape required. A heat gun can even be used to help form the extrusion into tight curves or other unique installations. PVC Snapp is great for direct waterfront applications as well as installation onto pressure-treated materials without the need of a bond breaker. PVC Snapp will accept all standard screen materials but fiberglass and polyester screening are preferred simply for ease of installation. Currently, PVC Snapp is available in stock 99-in. lengths or in pre-packaged porch screening kits from select retailers and directly from Connecticut Screen Works. Visit www.snappscreen.com.

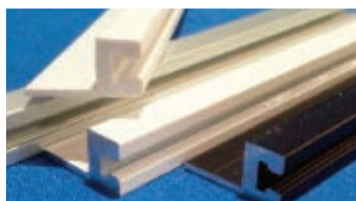

JOHNSON HARDWARE TRACKLESS DOOR GUIDES

Providing a more streamlined appearance, new Johnson Hardware Trackless Door Guides eliminate the need for a threshold or bottom guide track. So it's now much easier to travel through an entryway, especially for people who use walkers or wheel chairs. Nor is there any track or threshold to gather dirt and dust, meaning maintenance chores are a lot easier. Since there's no bottom guide track or threshold needed, bypass and multi-pass pocket door systems install easier and faster. Johnson Hardware trackless door guides all feature fully adjustable/removable door hangers for a precision installation, and smooth rolling nylon encapsulated ball-bearing wheels for easy gliding operation. Visit www.johnsonhardware.com.



GARDNER FLEX-N-FILL

Gardner Flex-N-Fill is a premium, all-purpose patching compound with a built-in primer. Tough enough for use inside or outside, Flex-N-Fill fills holes, cracks and indentations in drywall, wood, plaster and masonry surfaces. This premium spackling paste can be sanded and stays flexible to prevent cracks. And Flex-N-Fill's high-strength polymer formula has better adhesion and paintability

than traditional spackling compounds. Paintable in 30 minutes, the permanent Flex-N-Fill repair is a mold and mildew resistant and available in 8- and 12-oz. containers. Visit www.gardner-gibson.com.



**CONNECT RAILS & POSTS
IN JUST MINUTES**

SPRING BOLT™
THE Strongest Surface Mount
Railing Hardware Available



QUICK
Cut installation
time by 60%

STRONG
Unmatched
strength for both
interior and
exterior use

EASY
Less drilling, less
sanding, no wood
plugs and completely
hidden when installed

available at www.spring-bolt.com & www.homedepot.com
1.800.HOMEDEPOT

SPRING BOLT™
The Improved Wood Rail &
Newel Post Fastener

THE HOME DEPOT

Advertisers

March 2014

Amerimax	39	Maze Nails	19
Arke	17	Metal Ceiling Express	46
Armstrong Clark	15	MP Global Products	BC
Bessey	35	Muro	22
Bigfoot Systems	38	NyloDeck	47
Brush Weatherseal	13	Onduvilla	54
Bucket Ape	44	Oneida Air Systems	75
California Redwood Company	33	PacTool International	40
Cofair Products	50	Perma-Boot	25
Concrobium	51	Pine Hall Brick	23
Connecticut Screen Works	28	Proflex	69
Custom Service Hardware	24	Quick Screws	34
Daich Coatings	52	Ready Seal	10
DaVinci	21	Sakrete	80
Decks Unlimited	29	Schluter Systems	59
Dix Systems	65	Screw Products Inc.	45
Duckback	9	Seal Krete	20
Earthway Spray-Pro	12	Shelves That Slide	64
Elastilon USA	53	ShopBot	41
Elite Xpressions	77	Specification Chemicals	44
Energy Saving Products	71	Spring Bolt	79
Fasco America	49	Starrett	61
FrogTape	73	Step Warmfloor	76
Fypon	27	Sure Drive	43
Gardner	36	TG Tools	2, 3, IBC
General Tools	IFC, 1	Tjernlund Products	60
Grizzly Industrial	48	Tools 4 Flooring	74
GRK Fasteners	5	Touch 'n Foam	7
Gutster Demo Bar	40	Trac Vac	29
Howard Products	18	Tub O' Towels	4
Ideal Stair Parts	60	Txtr-Lite	66
Ingram's Water & Air Equipment	63	UGL	6
Jacks Small Engines	16	Versi-Foam Systems	68
Kaddies	72	Westbury Aluminum Railing	28
Land Pride	55	Woodworker's Hardware	62
Lumber Liquidators	11	Wooster	37, 67



YOU'VE GOT A PROJECT.

**WE'VE GOT
THE PRODUCT.**



FROM REPAIR TO ONE-OF-A-KIND MASONRY WORK, THERE'S A SAKRETE® SOLUTION FOR ALL YOUR CONCRETE PROJECTS.

SAKRETE® Flo-Coat Resurfacer is a highly flowable material that can be easily applied with a squeegee, making old concrete look like new again without the expense of replacement. The originator of pre-mixed bagged concrete, SAKRETE® has offered contractors and do-it-yourselfers innovative, readily available solutions longer than any other brand. Let us help you find the right product for your project.

Visit us at sakrete.com or call 866-725-7383.



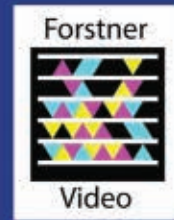

Spade



Brad



Forstner



When performance countsTG Tools United Co.
TGTools@sbcglobal.net or 800-687-4122 or www.mytgtools.com



THE HEAT IS ON!

NEW!

QUIETwarmth[®]

RADIANT HEAT UNDERLAYMENT

- Floating radiant heat panels ideally suited for floating tile, laminate and engineered wood flooring
- World's easiest radiant heat system to install, uses no thinset or self-leveling mortar
- Designed with recommendations from flooring manufacturers



Heat your FLOOR for PENNIES a day!

MP global products L.L.C.
 (888) 379.9695 quietwarmth.com

SURFACES

Stop by our Surfaces Booth #B3233 to see this new INNOVATION in flooring underlayments!

PROUD MEMBERS OF



THIS IS PAINT-SPRAYING TECHNOLOGY SO ADVANCED, YOUR BACKYARD FENCE WON'T KNOW WHAT HIT IT.



Powerful X-Boost Turbine™ provides maximum control with full coverage.

Revolutionary iSpray® technology sprays unthinned paint.

Quick-change nozzle allows you to easily switch coatings and colors.

INTRODUCING THE REVOLUTIONARY NEW ALL-PURPOSE FLEXiO SPRAYER.

The Wagner FLEXiO™ Sprayer delivers a smooth, professional coat to almost any surface, from garage doors to bathroom walls, from fences to living room ceilings. You can spray almost any paint or stain, including unthinned latex, with enough control for detail work. Say goodbye to old-fashioned brushes and rollers. It's time for a smarter way to paint.

View a video at WagnerFlexio.com



Revolutionary iSpray technology
sprays all coatings
including unthinned paint.

PAINT SMART.

WAGNER

A NEW LEVEL OF VISIBILITY

Kapro's 905 Condor with OPTIVISION™ Red



Optivision™ is a Kapro invention that creates the effect of **strong color definition around the level's horizontal bubble**, in stark contrast to the white vial background and clear liquid. The color contrast makes the bubble edges significantly easier to see, for fast and accurate placement between the vial's reading lines.

- **Highly visible** red bubble edge
- **Fast** placement between reading lines
- **Easy** viewing with tilted vial
- **Precise** leveling results
- **Gradient Lines** for slope measurements

The Condor level features Kapro's **Plumb Site® Dual-View™ vial** with **RedEffect™** – which makes the plumb vial even easier to see. Oversized rubber end caps protect the reinforced box profile from knocks and falls, and the Ergonomic handle offers extra comfort for large hands. A bridge at the horizontal vial adds durability and allows you to draw an uninterrupted line. The Optivision™ vial meets the highest standards of accuracy today, 0.0005"/" (0.5mm/m), and comes with a lifetime warranty.

Innovative features - Added value - Get the job done quickly and accurately.

For more information: www.opti-vision.com

www.kapro.com

<http://www.youtube.com/user/KaproTools>

Facebook: <https://www.facebook.com/kaprotoolsco>

www.shopkapro.com

