

Installations: Ceiling Fan • Cupola • Clay Paver Patio

Extreme How-To

The Enthusiast's Guide to Home Improvement

THE PERFECT WORKBENCH

PLUS:

UPGRADING A
STRIPPED-DOWN
UTILITY TRAILER

NEW JIGS AND
ACCESSORIES

July/August 2014 | ExtremeHowTo.com

\$4.99US \$4.99CAN





TG
KIK
PRO SERIES

www.MyTGTools.com

YOUR ONE SOURCE SOLUTION

**FASTER
 EASIER
 CLEANER**

KIK® Forstner Bit

KIK® HS Brad Point

KIK® Spade Bit



**135° Split Point start from Contact
 3-flat shank, less chuck slippage**

Concrete

High Speed

Titanium
 Coated
 High Speed

Heavy Duty

Solid Cobalt

S&D

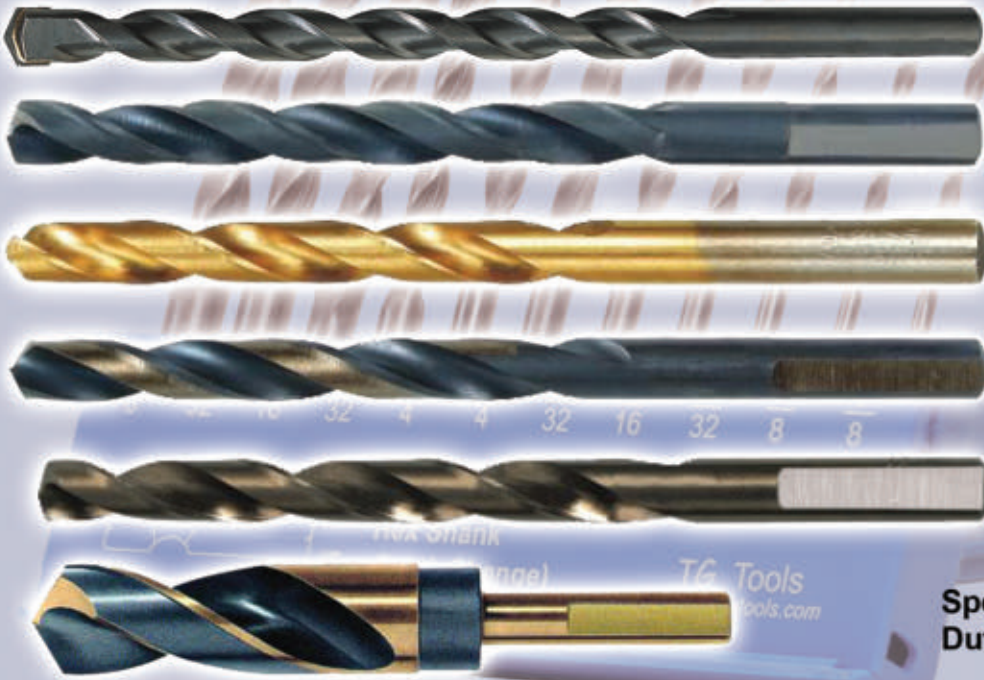

**Stronger, Faster
 Less Walking**

General Purpose

Longer Lasting

**Heavy Duty
 Steel Usage**

**Heavy Duty
 Steel Usage**

**Special Use Heavy
 Duty Steel Usage**

www.MyTGTools.com/kik1.php 1-800-687-4122

TG® Tools • 1010 Cedar Ave. • St. Charles, IL 60174 • ph 800-687-4122 • fax 630-584-4722

We Put a **KIK**® in Your Boring Tasks!



6 Cutting Edges

The revolutionary **KIK**® Spade Bit has over 30% more cutting surface making them much faster and longer lasting than standard spade bits. There is no protruding tang to bend or break allowing these bits to even bore non-ferrous sheet metals and curved holes too! Tested and Proven Superior by an Independent Lab.

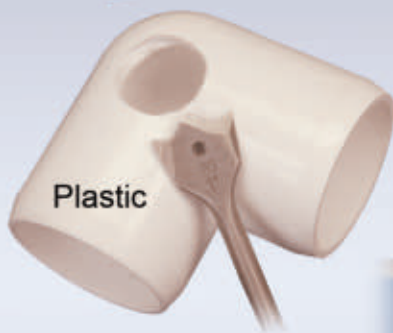

Plastic

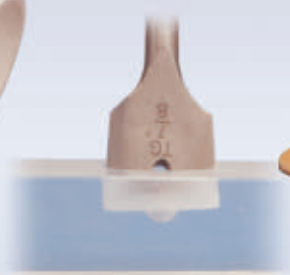

Acrylic



Brass

6 Cutting Edges



KIK® HS Brad Point

Independent Lab Tested and Proven
Designed for Drilling Sheet Metal, Wood and Plastic Faster, Cleaner with Longer Life and no Walking on the Surface.

In Wood:

- **Approximately 100% Faster** Compared to Common Brad Point
- **40% Faster** Compared to Standard Drill Bits

In Sheet Metal:

- **50% Cleaner** Entry
- Consistently **Round Hole**
- **20% Less Walking**

In Acrylic:

- **No cracking** Drilling Acrylic
- **150% Faster** Compared to Standard Drills
- **690% Faster** Than Other Brad Points

KIK® Forstner Bit

Proven Superior by an Independent Lab
Cleaner Entry and Exit

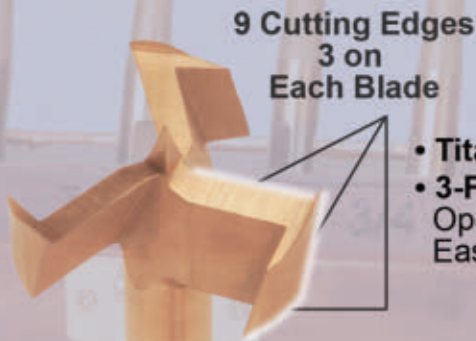

9 Cutting Edges
3 on Each Blade

- **Titanium Coated**
- **3-Flat Shank**
Open Head Design for no Clogging
Easy Drilling and Direction Control

- Bores through Hard Woods **100% Faster** Compared to Standard Forstners

- Bores
- Mills
- Routes
- Cuts
- Bores Curved Paths
- Channels

- Bores Through Acrylics **Cleanly Without Melting**
Able to Bore 90 Degree Curved Paths

www.MyTGTools.com/kik1.php **1-800-687-4122**

TG® Tools • 1010 Cedar Ave. • St. Charles, IL 60174 • ph 800-687-4122 • fax 630-584-4722

CONTENTS

July/August 2014

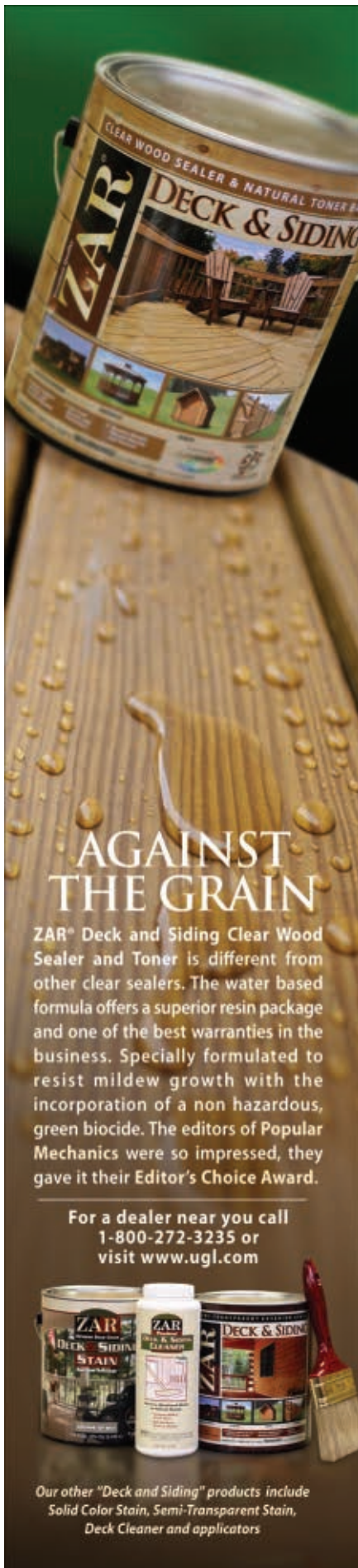

ZAR
CLEAR WOOD SEALER & NATURAL TONER
DECK & SIDING

AGAINST THE GRAIN

ZAR® Deck and Siding Clear Wood Sealer and Toner is different from other clear sealers. The water based formula offers a superior resin package and one of the best warranties in the business. Specially formulated to resist mildew growth with the incorporation of a non hazardous, green biocide. The editors of Popular Mechanics were so impressed, they gave it their Editor's Choice Award.

For a dealer near you call
1-800-272-3235 or
visit www.ugl.com

Our other "Deck and Siding" products include
Solid Color Stain, Semi-Transparent Stain,
Deck Cleaner and applicators



FEATURES

36 The Perfect Workbench

Give your workshop a workout by building the "perfect" workbench.

52 Installing a Cupola

Top off your roof.

60 Trick Out your Trailer

Upgrade a stripped-down utility trailer to move mulch and tow your tools.

RSSTM RUGGED STRUCTURAL SCREW



Quit wasting your time with pre-drilling lag bolts! From head to tip, the RSSTM is packed with patented features that significantly reduce torque and make it the strongest fastener on the market. ClimatekTM coated for superior corrosion resistance. You'll save time and energy with the RSSTM fastener from GRK!

*"Drive with Speed,
Quality and Confidence!"*

See for yourself and watch 'The RSS vs Lag Screw Challenge' video at www.grkfasteners.com

GRK
FASTENERSTM
ÜberGrade



800.263.0463



CONTENTS

EVERY ISSUE

- 8** From the Editor
- 88** Advertisers Index

COLUMNS

- 10** Q & A
- 14** Tool School
New Jigs and Accessories
- 28** Do-It-Yourself
Install a Clay Paver Patio

DEPARTMENTS

- 72** Project Next
Join the Fan Club
- 80** Hot Products



Cover photo © poplasen / Dollar Photo Club

Best Prices
Hardwood Floors starting at **99¢** sq.ft.

Highest Quality
The longest warranties on the market

Biggest Selection
340+ varieties to choose from

Expert Advice
Flooring experts in every store

Tranquility
Brazilian Koa Click Resilient Vinyl

HARDWOOD FLOORS FOR LESS!
LUMBER LIQUIDATORS
www.lumberliquidators.com
1-800-HARDWOOD



Scan, call or go online for a FREE CATALOG
<http://goo.gl/AL7pm>

STOPS LEAKS HERE



...AND HERE

Touch 'n Foam sealant products actually pay you back by keeping heat and A/C in the house where it belongs.

SEAL YOUR HOME WITH

Touch 'n Foam

- Fills gaps and cracks
- Stops drafts and energy loss
- Indoor and outdoor applications

Use smartphone scan or visit www.touch-n-foam.com for energy saving tips, to calculate your potential payback, and to find a retailer near you.



ENERGY TAX CREDIT ELIGIBLE

Back in high school, chemistry was never exactly my strong suit. I was interested in volatile chemical reactions, such as frothing desktop volcanoes and the excitement of a possible classroom explosion. But once all the letters and numbers got involved, the lengthy equations caused my eyes to glaze over. I lost all interest. It's a good thing that's not true of everyone, because the wonderful world of chemistry has given rise to a trio of the most innovative home-improvement technologies that I came across at this year's National Hardware Show in Las Vegas.

For example, a new product called Fast2K comes in a small book-sized pouch but replaces 50 lbs. of concrete for setting deck and fence posts. Having built both the deck and fence around my house, I know too well the sweaty, hard work involved with mixing concrete and setting a post, and it doesn't get any more fun when you have dozens more to go. With the new Fast2K product, just break the seal on the two-part pouch, mix for thirty seconds, position the post and then pour the product around the bottom. I watched a demonstration and was amazed at how the product expanded within two minutes to completely fill the space around the post, setting it securely. Check out www.Fast2K.com.

Another innovative product is Bondic, which is a liquid synthetic material that hardens in seconds using an ultraviolet LED. Unlike conventional glues that require the application of pressure or a lot of time for them to harden, Bondic offers an impressively simple alternative. Although the liquid adhesive appears and applies similarly to super-glue, it cures in a completely different way. The Bondic set includes a mini UV LED that emits precisely calibrated wavelengths of light. You can decide when and how soon you want the Bondic to harden using the LED. This type of repair enables users to fill in gaps left by missing fragments before hardening, in order to restore an object's function or appearance. Visit www.bondic.de.

Also, I discovered FiberFix, which is marketed as "100X stronger than duct tape". This patent-pending product looks much like fiberglass tape (the kind doctors use to cast broken bones) but is designed to provide the strength of epoxy. Just get the tape wet to activate the product, wrap the object to be repaired, and after 10-15 minutes of cure time

the FiberFix tape "hardens like steel". The repair is waterproof, sandable, paintable and resistant to heat and cold. Go to fiberfix.com.

My hat's off to the worlds' chemists. They stole the show at this year's convention. I'm always impressed by the real world solutions those savvy scientists devise using all those crazy equations.



EDITOR-IN-CHIEF
Matt Weber
mweber@latitude3.com

ADVISORY BOARD
Monte Burch
Rob Robillard
Larry Walton
Kathy Ziprik
Mark Clement

CREATIVE DIRECTOR
Wesley Glassco

CIRCULATION
Jennifer Pentecost

PUBLISHER
Jeremy Hollingsworth
jhollingsworth@latitude3.com

SENIOR ACCOUNT EXECUTIVE
Jan Logan
jlogan@latitude3.com

ADVERTISING SALES
Martin Smith
msmith@latitude3.com

Jason Holsomback
jholsomback@latitude3.com

Scott Shelley
sshelley@latitude3.com

ONLINE MEDIA ASSISTANT
Sonia Griffin

BUSINESS MANAGER
Dusty Statham

SUBSCRIPTIONS
Customer Service
888-587-8911

PRESIDENT
Trent R. Boozer

EXECUTIVE VICE-PRESIDENT
Chad Gillikin

EXECUTIVE VICE-PRESIDENT
Val Carrier

Extreme How-To is published by
LATITUDE3 MEDIA GROUP, LLC
2300 Resource Drive, Suite B
Birmingham, AL 35242
Phone 205.949.1600 • Fax 205.949.1601
www.extremehowto.com

Extreme How-To (ISSN 1540-5346) is published and distributed monthly to DIY home improvement enthusiasts by Latitude3 Media Group, LLC, 2300 Resource Drive, Suite B, Birmingham, AL 35242 (executive and editorial offices). All rights reserved. Neither this publication nor any part of it may be reproduced, stored in a retrieval system, or transmitted in any form or by any means, electronic, mechanical, photocopying, recording, or otherwise, without permission of Latitude3 Media Group, LLC. Subscriptions: U.S. and possessions: 1 year (9 issues - \$18.97); foreign, 1 year (9 issues - \$32.50) U.S. funds only. POSTMASTER: Send address changes to: *Extreme How-To* P.O. Box 4320, Oregon, IL 61061. SUBSCRIBER SERVICE: To order a subscription or change your address, write to *Extreme How-To* P.O. Box 4320, Oregon, IL 61061, or call 888-587-8911; or E-mail to ehw@pubdmgroup.com; or visit www.extremehowto.com. To order back issues, call (205) 949.1603.

The information in *Extreme How-To's* editorial content is intended to explain and simplify home-improvement tasks. Tools, products, materials, techniques, building codes and local regulations change; therefore, **Latitude3** assumes no liability for omissions, errors or the outcome of any project. The reader must always exercise reasonable caution, follow current codes and regulations that may apply, and is urged to consult with a licensed professional in doubt about any procedures. **Printed in the USA**

RELAX...DUCKBACK HAS YOU COVERED!



OUTDOOR SUCCESS!
FOR ALL SEASONS AND ALL ENVIRONMENTS

DIY FRIENDLY COATINGS WITH CONTRACTOR GRADE RESULTS

Deck restoration made easy! With Superdeck you can clean, stain and beautify in a few easy steps, allowing you to spend less time on projects and more time enjoying your home improvements.

Superdeck Wood Stains

- One coat coverage protects and beautifies
- Transparent iron oxide pigments for maximum color and UV protection
- Three oils gives wood the famous Superdeck glow
- Superior protection and water repellency



DUCKBACK.
Live the Outdoors!.

SUPERDECK.COM 1-800-825-5382

Q: I replaced the flooring in a bathroom. I reinstalled the toilet afterward, but the inlet to the tank is now 1/4 to 1/2 inch away from the water supply line, which is a rigid pipe that isn't long enough and refuses to budge. Can I inch the toilet backward to reach the supply line?

A: Assuming you've used a conventional wax ring gasket to install the toilet, you cannot reposition the toilet without compromising the gasket, which will likely result in a leak. Some newer toilet gasket products from companies such as Sani Seal are wax-free and repositionable, but you only get one shot at using a conventional wax gasket. At this point, the easiest fix would probably be to replace the old supply line with a flexible braided supply line long enough to easily reach the inlet of the toilet tank.

Q: What's the difference between enamels, latex-base and oil-base paints?

A: According to the experts at Sherwin-Williams, enamel is a broad classification for finishing materials that dry to a smooth finish. In the past this term referred only to oil-base coatings, but some new latex products are also referred to as enamels, which makes the word somewhat ambiguous as a paint term. Oil-base products are typically composed of pigments dissolved in a mineral spirit such as paint thinner. Latex-base products are an emulsion suspended in water. From a practical standpoint, the biggest difference is that oil-base paint requires mineral spirits for cleanup, have a longer dry time, have a stronger odor, but dry to a harder finish. Latex products typically will dry faster and are easier to clean up, requiring only water. Oil-base paints are used primarily where a harder finish is required. However, today's improved latex products allow the substitution of latex in nearly all scenarios that had traditionally called for an oil-base paint. (Source: www.sherwin-williams.com)

Ready Seal

STAIN AND SEAL LIKE YOU MEAN IT.
No Laps, No Runs, No Streaks, No Back Brushing.

Protect, beautify and prolong the life of any outdoor project with Ready Seal®, the professional-grade stain and sealer in one. Ready Seal goes on with no laps, runs or streaks for perfect results, every time. Available in one and five-gallon sizes.

MAHOGANY-030 DARK WALNUT-025B REDWOOD-020

GOLDEN PINE-100G LIGHT OAK-005 NATURAL CEDAR-012 PECAN-015B

ORDER ONLINE OR BY PHONE
www.ReadySeal.com | 888.STAIN4U

Goof Proof™

“The Product of Choice by the Professionals™”

Summit® ... responsible solutions.

Engineered by Nature



FOR ORGANIC PRODUCTION

Mosquito Dunks® Mosquito Bits®

Kills mosquitoes before they're old enough to bite!®

- #1 biological mosquito killer—kills mosquito larvae and nothing else!
- 100% natural, biodegradable, works for 30 days or more.
- Use in bird baths, planters, potted plants—in any standing water.
- Controls larvae within 24 hours—will not harm animals, fish, birds, honey bees or plants.
- Mosquito Bits®—a versatile granular application with a spice shaker top—easily broadcasts over treatment area.



NEW!
Now Controls
Fungus Gnats...

BIOLOGICAL Caterpillar & Webworm Control

- 100% natural alternative. Contains no synthetic toxins.
- Controls caterpillars and worms on fruit trees, vegetables, ornamentals, and shade trees in and around the home and garden.
- **USE UP TO THE DAY OF HARVEST.**



FOR ORGANIC PRODUCTION



Year-Round® Spray Oil

- Apply early in the growing season to prevent insect and fungal damage.
- Protection for your garden, vegetables, house plants, fruit trees, and ornamentals—both indoors and out.
- Recommended by top growers and agricultural experts.
- **USE UP TO THE DAY OF HARVEST.**



SummitResponsibleSolutions.com

800.227.8664

Q: Can PEX piping be used for outdoor applications, such as a water garden?

A: The PEX material can be used outdoors if it is buried or otherwise protected. PEX piping can deteriorate in the presence of ultraviolet rays, so it should not be used outdoors if it will be exposed to sunlight. That old standby, copper piping, not only resists corrosion but is also unaffected by ultraviolet rays, which is one advantage copper has over PEX. Copper would be better suited for any outdoor lines that will be exposed to the sun. You should also install a back flow prevention device to make sure no water from the pond can be siphoned back into your drinking system.

Q: How do I fix a sagging refrigerator door?

A: A sagging door isn't just an eyesore. If the gasket doesn't seal properly, the refrigerator will work harder to keep a cold temperature, wasting energy, costing extra money and stressing the appliance. This can also lead to frost buildup in the freezer. The door can be adjusted by removing the hinge cap and loosening the hinge screws. Align the door with the top of the refrigerator and then re-tighten. If the unit has both an upper and lower door, adjust the lower door first using the middle hinge, and then adjust the top hinge afterward to realign the upper door. **EHT**



**Call for pricing,
details on how to
order, availability.**



**10% OFF ALL ORDERS ON
ROLLING BARN DOOR HARDWARE.
Mention EHT 2013 in order to**

800-882-0009

1170 Wauwatosa Road Cedarburg, WI 53012

www.cshardware.com

Slab®

The Serious Fix for Concrete Cracks

• Sticks • Stretches • Stays





Fill Your Crack

Slab® is the concrete crack repair sealant you've been waiting for. Textured to simulate concrete, Slab combines the durability, flexibility & adhesion you need for lasting concrete crack repairs.

**Stop by the Extreme How-To Booth #6856
at the National Hardware Show
to receive a FREE gift!**



10300 E. 107th Place • Brighton, CO 80601
303-286-7271 • 800-767-5656
www.sashco.com

Keep up with SashcoInc on:   

New Jigs and Accessories



By Matt Weber

Jigs and tool accessories provide a handy way to get more efficiency, more versatility or more accuracy from your powered equipment. Attach an auger to your drill/driver to plant a garden. Use an angle gauge to transfer a tricky crown molding angle to your miter saw. With the right accessories your tools can do more jobs, and do them better. Here's a handful of power-tool helpers that are currently on the market.

POWER PLANTER AUGER

Whether you're planting annuals, shrubs, bulbs, or are mixing paint or small batches of concrete, the Power Planter Auger will speed up your job dramatically compared to using a garden shovel or trowel. The #207 Power Planter Auger

features a 3/8-in. non-slip hex drive that fits any 3/8-in. or larger corded or cordless drill. It's perfect for planting 4- and 6-pack annuals in containers or flower beds, as well as planting grass plugs. The 2-in. diameter by 7-in. long auger is constructed with a heavy-duty 5/8-in. steel shaft and durable 10-gauge flighting. The #207 Power Planters are hand-welded, hand-dipped in high quality gloss black enamel paint, and ship in a hangable box for pergboard storage. Power Planters are Made in the USA and come with an unconditional warranty on materials and workmanship, excluding normal wear and tear. Visit www.powerplanter.com.

GENERAL'S E-Z PRO CROWN KING

It's always a challenge to make accurate cuts in crown molding to create seamless joints at inside or outside corners. The new E-Z Pro Crown King (880) from General Tools & Instruments makes it a snap to cut crown molding accurately, eliminating trial and error and saving time and money. Unlike other crown molding jigs on the market, the Crown King



Give your wood a **MAKEOVER**



Amber Stain on teak and PT pine

Photo courtesy of Beth and Rod of See Dirt Run!

Professional grade yet homeowner friendly

ARMSTRONG'S WOOD STAINS

Long Lasting, Easy to Apply and a Breeze to Maintain

Manufacturers of VOC-Compliant, Oil-Based Wood Finishes

www.armclark.com • (800) 916-8211

PLEASE VISIT THE WEB'S PREMIERE SITES FOR OUTDOOR WOOD RESTORATION TOPICS AND DISCUSSIONS,
www.thegrimescene.com/forums www.thewoodpros.com

requires no assembly and is designed for the ultimate ease of use. It enables professional and DIY woodworkers to produce inside and outside corners with the three most common crown molding spring angles (38, 45 and 52 degrees). In combination with a miter saw, the Crown King can create precisely joining angles every time. Simply measure the corner angle, divide it by half, set your miter saw to



that angle, cut and fit. No complicated compound miter angle calculations are necessary. Visit www.generaltools.com.

SKELETON JIG SAW BLADES

Spyder introduces the Skeleton Jig Saw Blades. These blades feature a number of unique design elements that produce a cleaner, straighter and cooler cut in hardwoods, softwoods, synthetics, plastics and engineered wood products. The rectangular channel section cut-outs dissipate frictional heat throughout the length of the blade so it stays cooler, resulting in less deflection and straighter cuts than a traditional jig saw blade. What makes the Skeleton Jig Saw Blade a cut above the



competition is its rip-cut, gill-shaped teeth for highly clean and precise cuts. This design allows the blade to remove material on both the up and down strokes, and since the teeth maintain constant contact with the wood, the edges of the blade barely touch the sides of the cutting channel. Manufactured in Germany, the Skeleton Jig Saw Blades come in 10 TPI (Teeth Per Inch) and 12 TPI in both T-Shank and U-Shank configurations. Woodworking, multi-surface and combo packs are available. Visit www.spyderproducts.com.

HYDE DUST-FREE SPONGE SANDER

Convert your shop vacuum to a dustless sanding system with

Solve Indoor Air Quality and Comfort Problems



- XCHANGER™ Reversible Ventilation Fans and UnderAire™ Crawl Space Fans
- AireShare™ Room-to-Room or Level-to-Level Transfer Fans
- Balance Booster™ Reversible Transfer Fan
- Radon VAC™ Side Wall Radon Mitigation Systems
- Sure Dry™ Shower Drying Systems
- Clothes Dryer Duct Boosters®
- Auto-Draft® Chimney Top Fans
- Duct Booster® Standard & High Performance fans



Tjernlund Products
800-255-4208 • tjernlund.com



Improve Indoor Air Quality. Cure Damp-Musty Basements.

Also great for garages, cabins, storage areas & workshops

Two reversible fans supply air, exhaust or provide a balanced exchange. Built-in dampers prevent air infiltration. Adjustable dehumidistat and separate on/off switches for each 90 cfm fan included.

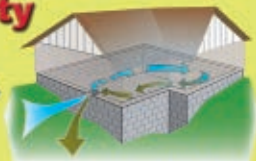

UnderAire™ Crawl Space Ventilators

Quickly reduces moisture helping to protect both home and occupants



Ventilates excess moisture, the cause of mold, mildew and wood rot. Increases air circulation to fight condensation. Constant operation helps vent radon, treated wood off-gassing and odors. Models V1D and V2D include adjustable dehumidistat, freeze protection thermostat and 115 VAC power cord.

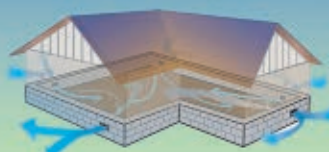

Tjernlund Products, Inc.
800-255-4208 • tjernlund.com



arke[®]
fontanot

SPIRAL STAIRS AND MODULAR STAIR CASE KITS

AVAILABLE THROUGHOUT THE USA, ARKE SPIRAL AND MODULAR STAIRCASE KITS CAN BE BUILT IN A DAY BY THE AVERAGE DO-IT-YOURSELF HOME ENTHUSIAST.

The OAK 70.XTRA ▶

The Oak 70.XTRA is an adjustable premier series spiral staircase that features solid Oak wooden stair treads and landing to complement and add style to any interior living space. Surrounding the full length of the staircase, the horizontal balusters and railing design is visually unique when compared to the traditional vertical baluster design of most stairs. The staircase can be easily installed by the homeowner in a single day using common household tools. The Oak 70.XTRA is available in 2 diameter sizes and is available in 2 choices of color...Hi-Gloss Black and Hi-Gloss White.

- Standard kit includes 12 oak wood stair treads, a landing, a complete handrail, and all necessary hardware and connectors.
- Diameters available include a 5 ft. 3 in. model and a 4 ft. 3 in. model.
- The height range for the standard kit is adjustable from 8 ft. 3 in. to 10 ft. 2 7/8 in. and with additional components, can be installed to a maximum height of 11 ft. 9 5/16 in.
- Powder coat finished painted in either Hi-Gloss Black or Hi-Gloss White.
- Can be installed in a clockwise or counterclockwise rotation.
- Stair treads and landing are made of solid Oak wood with a natural stain and a polyurethane protective coating.
- Balcony rail kits are available in matching color and horizontal baluster and railing design.
- Handrail is manufactured from an aluminum core surrounded by a soft PVC cover to allow the handrail to be curved at the time of installation to accommodate the radius of the staircase.
- Rise between stair treads is adjustable from 8 3/8 in. to 9 1/4 in.
- Interior installation only.
- A complete installation guide is included in all kits and an installation video is available upon request.
- Homeowner should consult with local building department concerning building codes prior to purchase.



arke[®]
fontanot

www.arkestairs.com

The Dust-Free Sponge Sander from Hyde Tools. This simple attachment cuts down on cleanup time by eliminating up to 95 percent of dust caused by sanding. It has a small profile, easy-to-grip

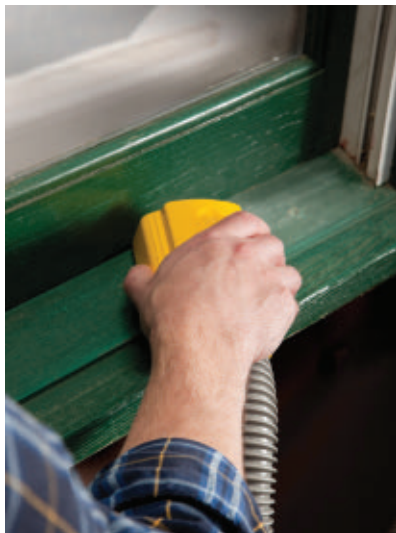

sanding head for use on flat surfaces, edges and corners, and will fit any standard shop-type or industrial vacuum. It can be used to sand any wood, drywall or metal surface. In place of sandpaper, the Dust-Free Sponge

Sander uses sanding sponges, which are both washable and replaceable. The kit includes a lightweight hand sander with two medium-grit sanding sponges and a vacuum hose. Visit www.hydetools.com.

AMERICA'S #1 RUST REMOVER



GREAT FOR:
ANTIQUES
AUTOMOTIVE PARTS
GARDENING GEAR
CAST IRON COOKWARE
AND MORE



**REUSABLE | NON-TOXIC
BIODEGRADABLE
SAFE ON SKIN & EYES**

VISIT OUR WEBSITE FOR A STORE LOCATION NEAR YOU!
AVAILABLE AT: HARBOR FREIGHT, TRACTOR SUPPLY, AND MORE

www.EVAPO-RUST.com



888.329.9877
MADE IN AMERICA

The Perfect Storm!

Innerglass Interior Storm Windows:

- insulate at a fraction of the cost
- compression-fit inside your existing windows
- are tighter than most insulating windows
- reduce heating & cooling bills up to 50%
- eliminate drafts completely
- snap in and out for easy cleaning
- greatly reduce outside noise



**Stop throwing your money away!
Call Innerglass today!**



1-800-743-6207 www.stormwindows.com



WE are AMERICA'S largest manufacturer of specialty nails!

Our reputation is on the line with EVERYTHING we make!

Ultimate corrosion resistant nails in double hot-dipped galvanized and stainless steel for these applications:

- Fiber Cement Sidings & Trim
- Cedar & Redwood Sidings
- Pressure Treated Lumber
- Fencing
- Post Frame Building
- Roofing
- Gutters & Trim
- PVC Moldings & Trim
- Decking
- Log Homes & Timber Frames



NAIL IT ONCE. NAIL IT RIGHT.®

A Division of W.H. Maze Company • Helping to build America since 1848



1.800.435.5949 • mazenails.com

MILESCRAFT 1312 DRILLBLOCK

The DrillBlock from Milescraft guides your drill bit for straight holes every time. The two V-grooves allow for drilling on

corners and even cylindrical surfaces, too. The inserted solid metal guide offers the six common drill diameters: 1/8, 3/16, 1/4, 5/16, 3/8 and 1/2 inch. The metal guide is held at a tight



tolerance and allows you to drill a hole 90 degrees to any surface, centered on a round item or even directly into the corner of your project. Centerlines ensure accurate alignment when drilling into various surfaces. The non-slip padding holds the DrillBlock in place when drilling. The ergonomic design of DrillBlock fits into the hands easily for comfortable usage. Visit www.milescraft.com.

TG TOOLS KIK SPADE BITS

For quick drilling of large holes, spade bits offer plenty of productivity with their paddle-like shape. The spade bits from TG Tools are engineered with 30 percent more cutting surface, resulting in faster boring and longer life. Plus, the Kik bits eliminate the spur commonly

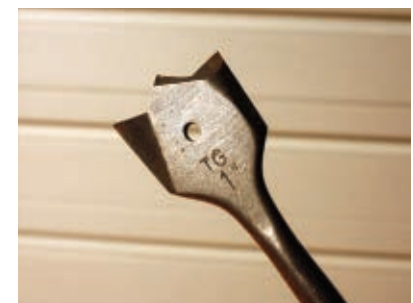

STRUCTURE

HIGH-VELOCITY WINDS

PREVENT UPLIFT

Bigfoot Systems® Footing Forms are not only used as pier footings for construction tubes, but they also act as an anchor to prevent uplift in areas subject to high-velocity winds.

FINISH GRADE

CONSTRUCTION TUBE

#4 or #5 REBAR

BIGFOOT

UNDISTURBED GROUND or 4" - 6" of COMPACTED GRAVEL

BIGFOOT SYSTEMS® The Original.

800-934-0393

www.bigfootsystems.com

Tips for Installing Concrete Pier Footings

Here are some useful tips to ensure your footings are installed properly and the integrity of your project is maintained:

- You should always make sure that a qualified engineer has designed your footing forms and that they have been tested by an accredited organization.
- Select a footing form that can carry the weight of your new construction and has met the proper building codes.
- Select a footing form made of environmentally friendly, sturdy materials.
- Ensure you are placing the footing form on solid ground. The more solid the ground the less likely movement will occur.
- Install your footings 4-6 inches below the frost line to avoid potential movement. If you are in an area without frost, then the form should be back filled 2 feet to hold it in place when it is being filled with concrete.
- Should rebar be required pour concrete into the system first. Insert three or four number 4 or 5 rebar rods into the tube. To determine the length of rebar, measure the distance from the top of the tube to the air holes located on the Bigfoot Systems® Footing Form before you place the system in the excavation and backfill.
- Purchase the amount of concrete started on the form label. You will use all of it.
- Use a Bigfoot Systems® Footing Form as a funnel to pour concrete into the system by placing an inverted Bigfoot on top of the construction tube.
- For a marine application, such as constructing a wharf, pour the concrete into the footing and tube on shore and have an excavator set them in place in the water. The other option will entail using a diver and pumper truck.
- Footing forms should always be used when installing footings as they provide added stability, strength and safety to your new construction.
- Don't risk having to redo the job, do it right the first time!

Visit our web site
www.bigfootsystems.com
 to view a complete set of
 our installation instructions.

Two MUST-HAVE Accessories for Every Tool Box



DrillBlock™

Drill Straight Holes All of the Time

- This lightweight but durable drill block allows you to accurately drill holes perpendicular to any surface including wood, plastic, glass, metal, tile, and more
- The integrated solid metal drill bushing block offers the six most common drill diameters: 1/8", 3/16", 1/4", 5/16", 3/8", and 1/2" (also available in metric).
- Centerlines ensure accurate alignment when drilling
- Continuous V-groove allows drilling on corners and through center of round objects
- Non-slip TPE foot pads, located on either side of the block, prevent slipping or marring of work surface



HookDriver™

Two-in-One Impact Ready Attachment that makes Driving Hooks Easy

- Drive screw hooks, eyelet screws, and L-hooks in seconds
- The detachable metal driver can be used in both corded and cordless drills in addition to an impact driver
- Comes with a detachable T-shaped grip handle that can be used with any 1/4" hex accessory



Always the Better Idea.

www.milescraft.com

found on similar bits, which allows these spade bits to drill a curved hole. Great for plumbing and electrical installations, simply start the drilling as usual and you can angle a hand drill as you bore,

altering the trajectory of the hole. The 7+1-pc KIK Spade Bit Combo includes 6 spade bits (plus a brad-point) and comes in a self-standing hinged case. Visit www.mylgttools.com.



VETO PRO PAC CARGO TOTES

Wouldn't it be nice to carry all your tools for a job in a single trip, without going back and forth to the truck or workshop? Veto Pro Pac has you covered. The new Cargo Totes are the first line of professional grade wide-mouth tote bags. "These rugged totes

Clamping Technology | Cutting Technology | Precision Steel



Simply better.

For 120 years now, whether it is clamping, cutting or steel technology, BESSEY® offers superior innovation, customer service and product quality.

Make the most of our innovative edge and accumulated experience and see for yourself why BESSEY® is... "Simply Better".

Join us on...

YouTube <http://www.youtube.com/user/BesseyTools>
 Facebook <http://www.facebook.com/BesseyToolsNorthAmerica>
 E-Newsletter <http://eepurl.com/erGnk>
 Website <http://www.besseytools.com>
 For information call - 1-800-828-1004

RAPID ACTION CLAMP

The Rapid Action Clamp comes with a double spindle mechanism (for accelerated clamping action) and a guided clamping bolt for very direct pressure. A robust tool to enhance shop productivity.

BESSEY® Simply Better.



AV2 SPACER

With adjustable settings (5-20 mm), durable construction and a wide contact surface area, the AV2 Floor Spacer is a big improvement over wedges or scrap wood for the laminate flooring professional.

BESSEY® Simply Better.



AV2 Video



AUTO-ADJUST TOGGLE CLAMP

The BESSEY Auto-Adjust Toggle Clamp automatically adjusts to variations in work piece dimensions while maintaining constant clamping force from 25 to 550 lbs.



BESSEY Tools offers two horizontal versions and an Inline version with new offerings coming Fall 2012.

Toggle Video



SPEND LESS TIME MOWING AND MORE TIME



ZEE 2

- Kawasaki® Engine
- 42", 48", 54" Cutting Widths
- Heavy-Duty Transaxles
- Formed & Welded Decks
- Stainless Steel Fenders
- 3 Year Limited Warranty

Zee 2 - 2354HP Shown

The switch from a garden tractor to the Zee 2 from Dixie Chopper can cut your mowing time in half, giving you more time for everything else in life. The Zee 2 is the industry's best mower in its class with commercial quality components built into a bulletproof residential design. See your local Dixie Chopper dealer today to see how you can save time with a Dixie Chopper.

JACOBSEN
A Textron Company

765-CHOPPER
dixiechopper.com

DIXIE CHOPPER
The World's Fastest Lawn Mower.

provide a versatile storage solution for a wide variety of job site situations,” says Roger Brouard, founder of Veto Pro Pac. “They are perfect as a catch-all bag for raiding the van; a carry-all bag for end of day cleanup; and they provide a more efficient way to organize the back of the truck.” Designed to stand up to the rigors of daily use, Cargo Totes feature 1800 Denier Body Fabric, leather handle grips and Veto’s signature 3mm thick polypropylene waterproof base. The *EHT* staff has been hauling these Cargo Totes around every job since we got our hands on them because they add so much grab-and-go convenience for whatever mix of tools you need. Throw in your circ saw, recip, drill/driver and socket set. You’ll be surprised how much can fit. Two sizes are available, both highly recommend. Visit www.vetopropac.com.



DECK DYNASTY

FASTER INSTALLATION. STRONGER CONNECTIONS.

Nobody can help you make stronger decks than us. Our patented DeckLok lateral anchor systems reduce time, cost and risk with more solid connections. Available in post-manufactured, hot-dip galvanized and 316 stainless steel, they help you exceed IRC 2006 requirements with both easier installation and increased load capacities. Find out more online.

DeckLok and all our decking fasteners are in stock, ship same day and are available with prepaid freight.

SCREW-PRODUCTS.COM



THE ULTIMATE FASTENERS



Cox residential

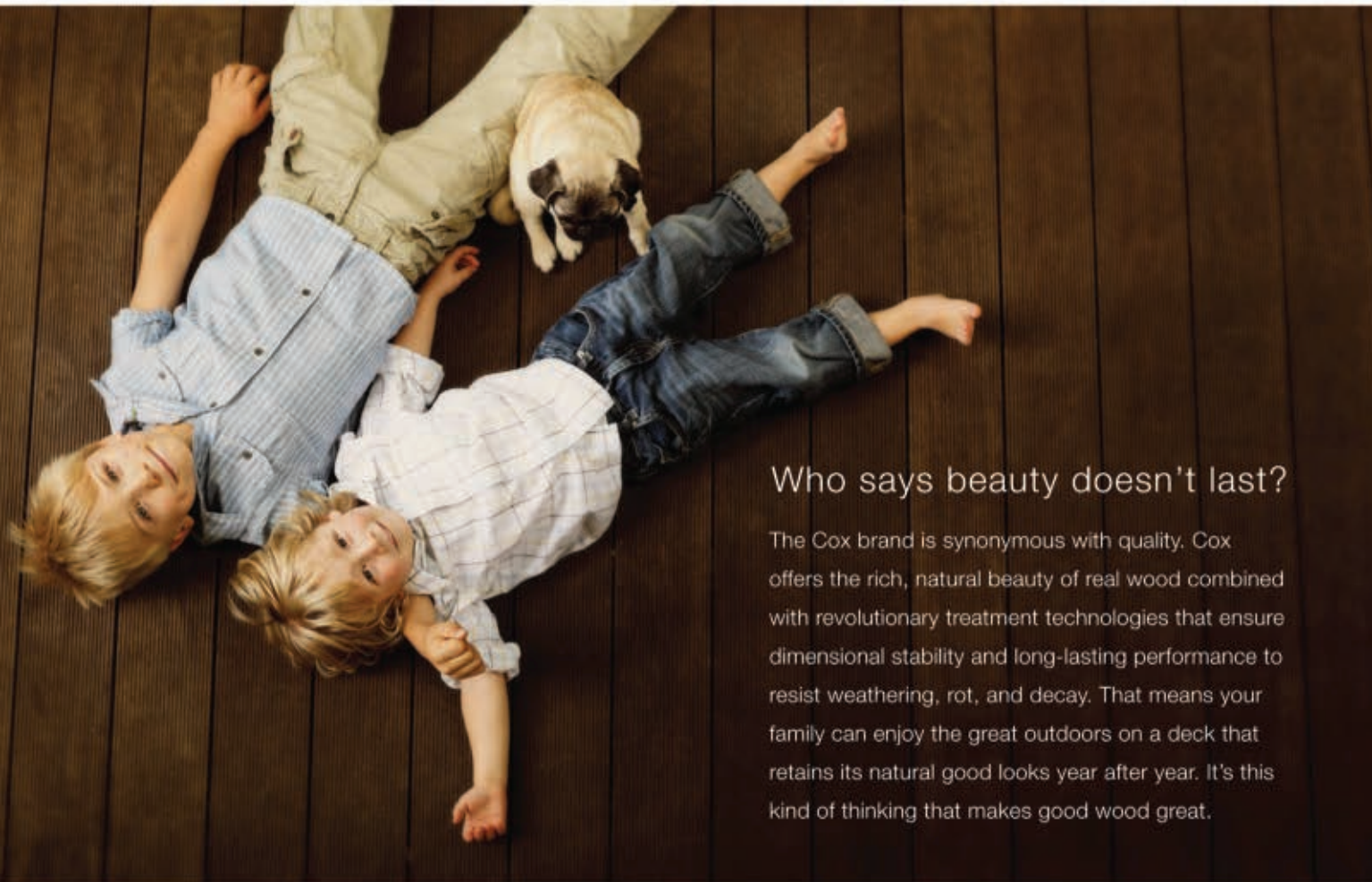

Who says beauty doesn't last?

The Cox brand is synonymous with quality. Cox offers the rich, natural beauty of real wood combined with revolutionary treatment technologies that ensure dimensional stability and long-lasting performance to resist weathering, rot, and decay. That means your family can enjoy the great outdoors on a deck that retains its natural good looks year after year. It's this kind of thinking that makes good wood great.

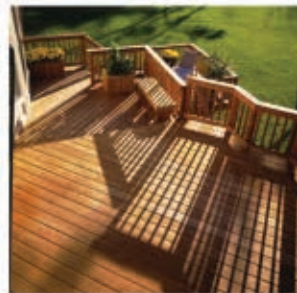

Find a Dealer. Become a Dealer.
800.476.4401 | www.coxwood.com

Cox *Better Ideas. Better Wood.™*

RESIDENTIAL

UTILITY

MARINE

MILESCRAFT JOINTPRO

The 1311 JointPro jig from Milescraft makes it easy for even novice woodworkers to make

professional-caliber doweled joints. The interchangeable hardened steel bushing blocks allow you to drill up to six matching holes per set-up quickly and

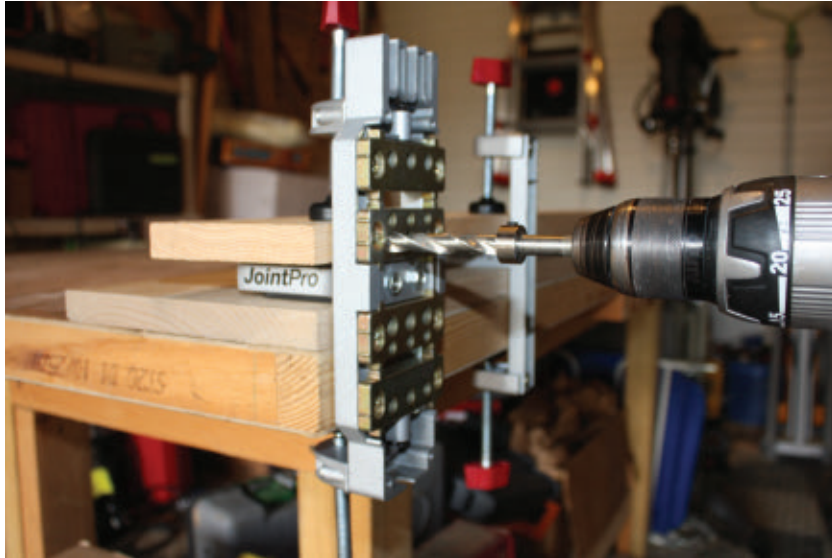

accurately for edge, corner and surface joints. The self-clamping jig securely holds the work pieces in place and guides your drill for perfect hole placement. Two detachable clamps allow for horizontal or vertical positioning. The JointPro also includes non-slip pads that prevent the work-piece from slipping and marring. Visit www.milescraft.com.

MILESCRAFT 8402 ANGLEFINDER

AngleFinder is a reference for angle measurements for precise woodworking. Looking to divide your angle in half for miter saw set-up? The AngleFinder does all the work for you. The yellow angle divider divides any angle in half. It features an angle-measurement readout, allowing you to set your angle once determined. The locking lever lets you secure your angle in place while transferring it to your miter saw. Looking to find an angle in a tight spot? The retractable edge guides allow you to get into confined spaces and determine the angle. Visit www.milescraft.com.

NOT JUST A HOUSE...



NOT JUST A STAIN...

Hemp Shield™ is a "Revolutionary" One-Coat Satin Finish for vertical log, siding surfaces, decks and fences. Hemp Shield's "Revolutionary" state-of-the-art formula contains **100% PURE HEMP OIL** providing longer wood durability. Hemp Shield Clear preserves the wood's original color, tone, and shade.

Why HEMP OIL? Deeper molecular penetration into logs, siding, decks and fences versus stains used by other manufacturers.

Please visit our website
www.Hempshield.net

- EXTREMELY HIGH UV RESISTANT
- VERY LOW IN VOCs • ECO-FRIENDLY
- MILDEWCIDE, ALGICIDE, & FUNGICIDE CONTAINS NO FORMALDEHYDE
- USE EXTERIOR OR INTERIOR
- EASY CLEANUP



MILESCRAFT 1400 UNIVERSAL SAWGUIDE

The Milescraft 1400 Universal SawGuide serves as an edge guide for circular saws and both an edge and circle guide for jigsaws. The attachment works equally as well from the left or right hand side, and the exclusive trimming feature allows you to adjust length of cut by 1/8-in. increments without tools. Multiple holes in the guide head compensate for varying bar widths, ensuring precise alignment of the jig's blade when cutting circles. A tooth-gear design allows toolless exchange of the four different bars of varying widths to permit easy attachment to most circular and jigsaws. Visit www.milescraft.com.



DIABLO FLUSH CUT RECIPROCATING SAW BLADES

Freud America has introduced two new specialty flush cut blades for reciprocating saws. The new Diablo Flush Cut Blades are designed to handle nail-embedded wood and metal. These Bi-Metal Reciprocating Saw Blades come in 9- and 12-in. lengths (DS0194AFC and DS1214AFC) and feature the optimal flexibility to bend between or beneath boards for flush cutting. They have a unique tooth configuration for smoother cuts with less vibration and deliver up to four times longer cutting life than standard bi-metal blades. The new Flush Cut Blade features Perma-SHIELD non-stick coating that reduces heat, gumming and corrosion. Visit www.diablotools.com. **EHT**



An American Original!

DUCK TAPE
BRAND DUCT TAPE
ORIGINAL STRENGTH
MADE IN USA

STRONG • STICKY • WATERPROOF

Trust Duck® brand duct tape to deliver the quality and strength needed for every project.

MADE IN USA

DuckBrand.com
©ShurTech Brands, LLC 2014/57629

Install a Clay Paver Patio



Installing a clay paver patio is great DIY summertime project that enhances the look of the home's outdoor environment.

By Walt Steele

The warm weather is here, and it's time to get outside. A good summertime project for DIY'ers is to build a patio of genuine clay pavers. To get started, figure out how you plan to use the space.

Gather everything that you will regularly want on your patio—the grill, the children's toys, patio furniture—and place everything where you will want it to go. Use a garden hose or spray paint on the grass to outline the size of the patio.

Visualize beforehand how you want the patio to look. Think about what the overall shape will be and what pattern you'll use. A curved

patio, for example, is less formal than a rectangular or square one. In terms of patterns, a basket weave pattern is ideal because full pavers can be used throughout in a square or rectangular shaped installation. Using a running bond or 90-degree herringbone in rectangular areas will only require half-cuts, while a 45-degree herringbone requires cuts around the entire perimeter. That would mean renting a wet saw for at least a day, which would add an additional expense to your project.

And before you start digging, always make sure the underground utilities have been located and marked.

Conventional installations require pavers, crusher run gravel and sand, edge restraints, a compacting machine or hand-held tamper and a broom.

As a general rule, conventional pavers require about 4 inches of compacted crushed stone as a base for pedestrian use; or deeper, to up to 8 inches for more harsh climates where ice heaving is a problem. For vehicular uses, a base of between 8 and 12 inches is recommended. Another good rule of thumb is to find out the generally accepted practices in your area and use them.

Dig down deep enough to include the depth of the crusher run gravel, one inch of sand on top of that, and the paver itself. When you're done, the paver should be flush with the top of the ground. Dig six inches out beyond the area you will pave. Slope the soil about 1/4 inch per foot to allow for proper drainage away from the home. Next, tamp the soil down with the tamper or plate compactor.

Put down the crusher run gravel and compact it well. Then, lay down two lengths of 1-in. PVC pipe, parallel to each other and several feet apart. Cover the pipes with concrete sand (course, jagged sand) and use a board across the top of the pipe to screed the sand level.

Remove the pipes and use a trowel to fill and smooth the voids. Lay the pavers in place, using string lines to ensure a straight pattern.

Next, install edge restraints,

VIRTUALLY INDESTRUCTIBLE IS NOW SUBMERSIBLE!

15 ft. ANSI FL1 drop tested

ANSI IPX7
Water Submersible



Shatterproof lens & reflector

RAYOVAC

500 LUMEN
High Performance LED
lasts up to **50,000 hours**
on High mode



Available at
Walmart

DO IT YOURSELF

which can be metal or plastic, or even a row of finished pavers stood on end and buried to finished height. Troweled concrete that's later backfilled can also be used as the edge restraint.

Tamp or compact the pavers into the sand bed using a piece of scrap plywood, a square of old carpet or a plastic pad on top of the pavers to avoid chipping. After that, sweep sand into the joints. In a week or two, you'll want to see if more sand is needed in the joints after it has settled.

EXISTING CONCRETE

To install pavers over an existing concrete patio or walkway, begin with thinner pavers that are 1-3/8 inches thick and made for this purpose.

Lay a "soldier course," which means laying a line of bricks perpendicular to the edge of the concrete to form the outside frame of your project. Use four

As a general rule, conventional pavers require about 4 inches of compacted crushed stone as a base for pedestrian use.



JACKS SMALL ENGINES
"AFTER THE SALE IT'S THE SERVICE THAT COUNTS!"

1.4+ MILLION
PARTS ONLINE

COMMERCIAL & BUSINESS
SAVINGS



**DISCOUNTED
LOW PRICES**

1-877-737-2787

www.JacksSmallEngines.com



dots of masonry adhesive on each brick, each about the size of a penny, which allows rainwater to pass underneath.

On the inside of the soldier course, cut pieces of roofing felt to put a single layer inside the frame covering the concrete. Don't overlap the felt edges. Then, lay a second layer of felt perpendicular to the first, over the top of the first layer. The felt keeps the pavers from rocking against the concrete when you walk on it.

Starting at one corner, begin laying the pavers in place, leaving a 1/8-inch gap between the pavers. Finish by sweeping sand between the joints until they are full.

PERMEABLE PAVERS

Permeable pavers are somewhat similar, except that special open-graded aggregates without fine particles are used instead of crusher run and sand. Additionally,

Cover the gravel bed with concrete sand (course, jagged sand) and use a board across the top of the pipe to screed the sand level.

Flex-N-Fill™

Gardner® Flex-N-Fill™ Premium Spackling Paste

Gardner® Flex-N-Fill™ is your premium, all-purpose patching compound with a built-in primer. Tough enough for use inside or outside, Flex-N-Fill™ fills holes, cracks and indents in drywall, wood, plaster and masonry surfaces. This premium spackling paste can be sanded and stays flexible to prevent cracks. And Flex-N-Fill™'s high strength polymer formula has better adhesion and paintability than traditional spackling compounds.

- Flexible permanent repair
- Paintable in 30 minutes
- Available in 8 oz. and 32 oz. square containers for easy access
- Patch & Prime in one step
- Won't shrink or crack
- Mold and mildew resistant

Learn more about Flex-N-Fill™ or any of our other maintenance and repair products. Visit Gardner-Gibson at the National Hardware Show booth #5212 or online at www.gardner-gibson.com.

**FLEXIBLE
NO CRACKS**



Flex-N-Fill™

www.gardner-gibson.com • 1800.237.1155

DO IT YOURSELF

the permeable pavers themselves have larger nibs—spacers that keep the pavers apart—and allow water to seep in-between them.

Figuring the depth of the underlayment is also different. The

standard method is to dig down a minimum of 12 inches. Some installations, such as streets, will require a deeper excavation. Since the idea is to trap stormwater and then release it slowly into the

DON'T GET STOPPED BY A DULL BIT AGAIN

SHARPEN DRILL BITS WITH EASE

WATCH THE DEMO VIDEO



DRILLDOCTOR.COM

- Easy to use and works every time
- Models priced to fit every budget and sharpening need
- 3 Year Warranty
- Sharpens from 3/32" to 3/4"
- Carbide, HSS, Cobalt, Titanium



Drill Doctor
The Drill Bit Sharpener



After placing the paver stones over the sand bed in your preferred pattern, sweep sand over the installation to fill the joints between pavers.

ground underneath, the depth depends on how much water needs to be handled, and that's a question for an engineer.

A #2 stone is used as a sub-base, followed by a finer grade of #57 stone. The bedding layer, just beneath the pavers, is made up of #8 or #89 aggregate, which is also swept into the joints. Every 4 inches of depth, the aggregate is rolled or compacted into place. Once the surface is prepared, the pavers are put into place. **EHT**

Editor's Note: Walt Steele, is a recognized expert on clay pavers. He is paver business manager for Pine Hall Brick Company. Steele can be reached at (800) 334-8689 and at waltsteele@pinehallbrick.com. For more information, visit www.PineHallBrick.com.

HARDSCAPE ON TOP

StormPave...it's like hiding your retention pond under your hardscape.

With a BMP installation, you can have a traditional clay paver hardscape and storm water storage too. StormPave permeable clay pavers have been independently tested to have an infiltration rate of 720 inches per hour.

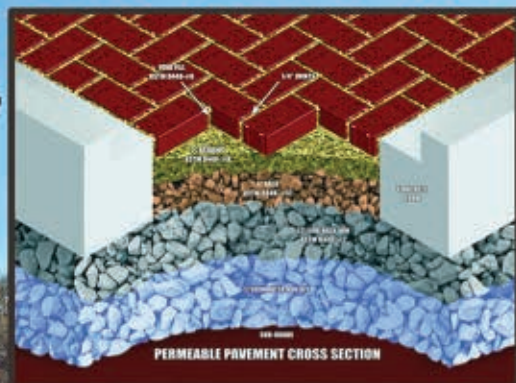

From the base storage, storm water can dissipate back into the soil or be routed to underground tanks to be used for landscape irrigation. Either way, you don't have to give up valuable real estate for a retention pond.

800.334.8689

www.americaspremierpaver.com

www.pathwaycafe.com

WATER STORAGE BELOW

STOP LEAKS PERMANENTLY. MAXIMIZE PERFORMANCE.



My Car A/C is Blowing Hot Air!



There is a quick and easy way to stop a leak in your car's A/C system that you can do yourself in your garage or driveway. **Red Angel A/C Stop Leak & Conditioner** is an easy to install A/C leak sealer by **BlueDevil Products**. Red Angel One Shot is a complete delivery system with 2.5 oz. of refrigerant and 2.0 oz. of leak sealer specially formulated to seal leaks while not clogging essential air conditioning components. It is also backed by a money back guarantee!

Red Angel A/C Stop Leak & Conditioner has the remarkable ability to repair and seal leaks in condensers, evaporators, connection hoses, gaskets, and o-rings. It contains no solid or particulate matter that will clog your A/C system or harm the recovery unit. **Red Angel** forms a chemical weld sealing leaks in your R-134a system, it's safe and easy to use and best of all — it's permanent. To read more about Red Angel and other BlueDevil Products, check out our automotive blog! at www.gobluedevil.com/blog









BlueDevil

PRODUCTS

STOP LEAKS PERMANENTLY. MAXIMIZE PERFORMANCE.

-  Guaranteed permanent repair for leaks in AC, Cooling & Fluid Oil Systems
-  Compatible and safe for gas & diesel engines / Easy DIY Solutions
-  Alternative cost-effective solution for vehicles not worth the hard part repair
-  Easy to use and non-harmful to vehicles, equipment, and shop machinery

For more information, please call 888.863.0426
or visit us on the web: www.gobluedevil.com/extreme







THE PERFECT WORK- BENCH

Give your workshop a workout by building the perfect workbench.

By Rob Robillard

Okay, that was misleading. There is no such thing as a perfect workbench. I can say this because I've built and rebuilt my workbench at least five times in twenty years and I'm now considering a new design. I'm not alone in this quest for the perfect bench.

A workbench can be the most essential part of your workshop or garage, but know that there is no "holy grail" of workbenches. The fact is that all workbench designs end up as a compromise.

Essentially, a workbench is a platform to get stuff done. It can be a simple table with a machinist's vise bolted to its top or built to accommodate a number of different work-holding mechanisms.

BASIC FEATURES

A good bench should be heavy enough that it doesn't move while you're working, and stiff enough that it doesn't rack to pieces under the forces that will be placed upon it.

Most DIY'ers would agree a good bench needs these key features: For starters, the base must be sturdy—no wobbling allowed. It must have a large, flat work surface that's rugged enough to stand up to years of hard use. It must be a comfortable height, and the bench should suit the type of work you spend the most time doing. Tool or parts storage is nice, but not critical.

There are many methods to build a workbench. You'll find a number of plans for sale online, all with varying degrees of cost and

THE PERFECT WORK- BENCH



Workbenches are built for many different jobs, such as this classic woodworking table. Woodworking benches usually include vises and other hold-down accessories.



sophistication, but most of them are really just tables. The key is finding the one that works best for you.

Woodworking benches tend to include elaborate work-holding systems with items such as bench dogs, planing stops, hold-fasts, board jacks, and will usually have one or more woodworking vises integrated into its structure.

If you're like me, however, you'll build your own solid, versatile work-surface for assembling all types or projects, including home repair issues like repairing a wobbly stool or re-sharpening lawn-mower blades. It's nice to keep the cost down, too.

DESIGNING YOUR OWN WORKBENCH

If you're considering making your own, take a moment to examine

how you will use the workbench. Analyze your needs based on the type of things you do in your workshop, the types of tools you use and your workshop or garage's limitations.

I use a principle of simple observations in almost all aspects of my work, designing a workbench included. It's called the Pareto's Principle or the 80/20 Rule. I've used the 80/20 observation to determine how to build a workbench, size, height, accessories and other factors. The 80/20 refers to the "vital few and trivial many". The principle states that 20 percent of work is always responsible for 80 percent of the results. That means I need to focus my design on the 20 percent of my work that really matters. Don't just "work smart", work smart on the right things.

So how do I apply this to my work bench? It means building a bench that optimizes your specific tasks. For starters, figure out the specific tasks for which you will most often be using the bench.

To me, there are three basic workbench use applications: General work/construction; sanding, cutting and hand-plane applications; assembly and repairs.

Here are some important design considerations you should consider. Ask yourself the following questions:

- Is your bench going against a wall?
- Do you need 360 degree access to your bench?

ANY ENGINE



Since the introduction of the first synthetic motor oil to meet API service requirements, AMSOIL technology has set the performance standards for the most advanced engines in the world.

AMSOIL for any engine.

AMSOIL

The First in Synthetics

www.amsoil.com

1-800-777-8491



THE PERFECT WORK-BENCH



Here's an example of a custom-built assembly table (no top yet).

- Will you be placing heavy objects on the bench?
- If yes, should you install casters for mobility and storage?
- Will casters affect your working applications, such as hand-planing?
- Will you be mounting a vise, saws or other bench-top tools permanently?
- Do you need shelf or drawer storage?
- Do you have space to stretch out long boards?
- Have you considered electrical and lighting considerations?

HOWARD "Restore It Don't Strip It!"



- Restores Color to Faded Wood Finishes
- Blends Out Scratches and Blemishes
- Removes Water Marks and Heat Rings

Call Us Toll-Free or Visit Our Website
to Find a Retailer in Your Area



www.HowardProducts.com

Howard Products, Inc. • Paso Robles, CA USA • (800) 266-9545

Once you answer these questions you'll have a good idea of what type of a bench you need, with the least amount of compromises. The goal is to design a bench that meets your needs for the majority of situations.

CORRECT WORKBENCH HEIGHT

Customize the size of your workbench to your body height. Most workbenches range from 28 to 36 inches deep, 48 to 96 inches wide and 28 to 38 inches tall.

TIP: If you're unsure about your preferred bench height, build your workbench legs without a horizontal cross brace at the floor. This way if the bench is too high you can later trim it down in height.

The amount of space you have available will likely dictate its



This photo shows the assembly table being used as an outfeed bench for a table saw, while providing ample tool storage.



WEEKEND PROJECTS



GARAGE FLOORS

EPOXY-SEAL CONCRETE & GARAGE FLOOR PAINT

- 3x More Durable Than Porch & Floor Paint
- 1 part Epoxy, Easy to Apply
- Resists Peeling, Blistering, Automotive Fluids, Road Salts, & Hot Tire Pick-Up



BASEMENT WALLS

DAMPLOCK MASONRY WATERPROOFING PAINT

- Resists 15 psi of Water Pressure
- 15 Year Waterproofing Warranty
- Resists Mold & Mildew



extreme.seal-krete.com

HOW TO TREAT CONCRETE®

800-323-7357

THE PERFECT WORK-BENCH



When incorporating a bench into your garage or workshop, don't forget to provide power for lighting and electrical outlets.

depth and width. Size your bench so you can move material and equipment past it freely, and so it's not a constant obstacle in your workspace.

WORKBENCH HEIGHT RULE OF THUMB:

General work: For basic joinery and construction, set the top of the bench to your belt line

Sanding, cutting, hand-plane work: Set the top of your bench 6

inches below the belt for better leverage

Assembly and repairs: Set the table top 6 inches above the belt.

Assembly of large items: Set the table top 12 inches or more below the belt.

BUILD IT STRONG

The secret to the strength of any workbench is selecting the right materials and building a sturdy base and top. A simple,

cost-effective workbench can be built with 2x or 4x stock, and the top, shelf, and end panels can be sanded plywood or plank stock. I choose these materials for their sturdiness, low cost, and ready availability.

When assembling the bench, keep fasteners and joinery simple. Use glue, and pre-drilled lags or structural screws. Build your bench like a house with continual point load and a strong foundation.

Resting the tabletop on the legs is stronger than attaching the legs from the side using only fasteners. Again, this all depends on how much weight you plan to put on the table. Are you building cedar birdhouses or rebuilding a Chevy V-8 engine?

TIP: For wall-mounted workbenches, install the bench on a ledger board or blocking mounted into existing wall studs. Align the tabletop so the ends of the plywood are even with the outer edges of the studs. Most studs are laid out and installed 16 inches on center, and this works well with plywood sheet stock measurements. Additional studs or supports can be added if needed.

GARAGE DOOR CHECKUP

For many DIY'ers the home's garage doubles as the home workshop, and proper maintenance is important. Corrosion and metal fatigue will eventually cause the components of a garage door to fail, but you can extend its life with a little annual upkeep. Lubrication prevents corrosion and allows the moving components of the door to move more quietly and smoothly with less wear from friction. Lubricate the the chain drive (or screw drive) with white lithium grease, available at any home center. You can coat overhead torsion springs or extension springs with standard WD-40.

Check the door rollers every year for wear and tear. Nylon rollers tend to crack apart, and the worn bearings of steel rollers can cause the wheels to deflect. Replace as needed by removing the roller bracket (but do not remove the bottom bracket).

If the door doesn't close far enough or returns once it hits the floor, you probably need to adjust the travel setting of the door opener. Check with your manufacturer to determine the adjustment procedure. Some door openers have set screws you can adjust with a screwdriver, while other units have knobs or trip levers for adjustment.



Hi-Velocity Systems™

www.hi-velocity.com

Small Duct High Velocity Heating, Cooling and Indoor Air Quality Systems

Many Attractive
Vent Plate
Finishes Available



Small Diameter Flexible Duct fits
in confined areas with no major
remodelling



Ideal for Residential, Multi-family,
Retrofit and Commercial Applications

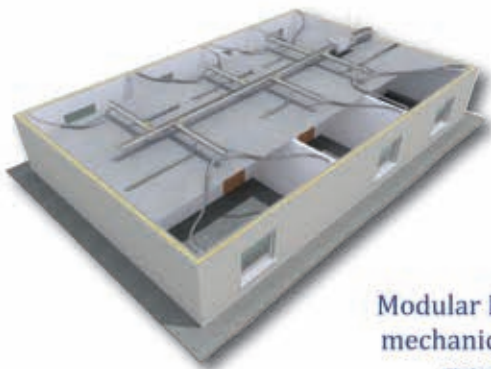

Modular Fan Coil Units fit easily in
mechanical rooms, closets, attics,
crawlspaces, anywhere!



Hi-Velocity Systems™ are engineered to deliver quiet
comfort, superior performance and energy efficiency.

*Energy Saving Products Ltd.
Proudly Family-Owned since 1983
Call us today 1-888-652-2219*

THE PERFECT WORKBENCH

STORAGE

Consider incorporating storage options into the bench or its surroundings. The more shelves, drawers and tool holders one has, the better. All the nooks and crannies add up to lots of storage space, which makes it easy to organize and locate needed tools, supplies, fasteners, etc.

I'm a big fan of cabinet doors and shelves to hide my tools and keep them dust-free, but doors and drawers do add cost and complexity to the building process.



POWER AND LIGHTING CONSIDERATIONS

Plan for electrical power and lighting. If you're fortunate enough to be wiring your own shop, dedicate 20-amp circuits along the walls, including one or two for your workbench.

Proper lighting in your workshop is as important as any tool in your toolbox. Whether it's to see what you're doing, to illuminate mill marks on wood surfaces or for photographing of your work, having adequate and proper lighting

is important. Make sure you have ample lighting positioned to reduce shadows that may compromise productivity or safety.

Most of the light in the workshop should come from overhead lighting. The overhead fixtures should be spread out to provide consistent overall lighting throughout the entire shop without major dark spots.

Fluorescent lighting is the least expensive way to light a workshop. These fixtures can be installed with screws, and are no more difficult than installing a regular light fixture. The lights are bright, use very little electricity and are easily replaced.

Spot lighting can also enhance the workspace. In addition to the overhead lighting, it may be advantageous to place recessed flood or spot lights directly over some of your tools and workbenches.

Many tools now come with on-tool lighting. My drill press is one of them. You can purchase aftermarket lighting with heavy-duty

Adding storage options to your bench or its surroundings will help organize the workspace.

BEEFY SHOP-MADE WORKBENCH

This workbench, which we use in the EHT workshop, is constructed from 2x6s, 2x4s and 2x2s. I first ripped the rounded edges off the lumber, so each 2-by-4 measured 3 inches, and each 2-by-6 measured 5 inches. I then assembled it according to the diagram, sizing the height for a 6-ft. tall person to work comfortably, but you can adjust the height of your bench accordingly. I used 2-1/2-in. No. 8 wood screws when fastening through 2x lumber into the face of another 2x board. I used 3-in. screws, however, when fastening through 2x lumber and into the end of a board. Make the bottom shelf by cutting your sheet material of choice to fit flush into the lower frame over the 2x2 edge supports, and fasten with 1-5/8-in. wood screws. The sturdy top is nothing more than a solid-core door available at any home store, centered on the table frame and screwed to the brackets from beneath. — *Matt Weber, EHT editor-in-chief*

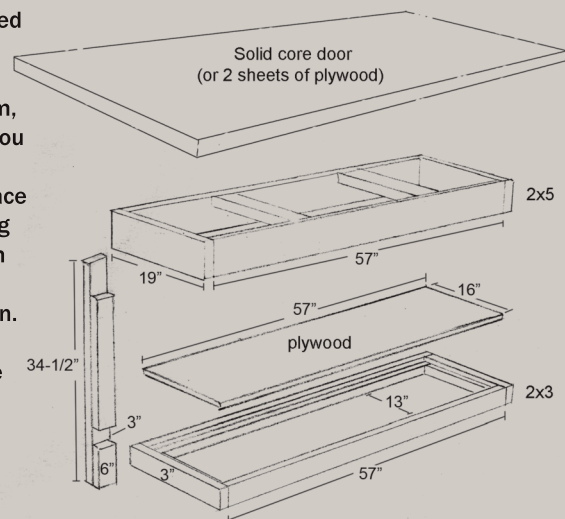



Shelves don't have to be fancy. Simple wooden platforms can store items off the floor and easily visible.

magnets or just install a simple clamp light to such tools. These task lights are a great supplement to your overhead lighting but should not be a replacement for poor shop lighting.

If you have cabinets over a workbench then under-cabinet lighting is a perfect solution for task-lighting the bench.

Finally, as good as your bench is, you can make it even more versatile by adding a bolt-on woodworking or mechanic's vise.

HOW TO BUILD A ROUGH SAWN WORKBENCH

The workbench shown here was made of materials left over from

a previous project. Most of the workbench parts came from rough sawn 2x10-16-ft. staging plank material. The planks sell for \$34.00 each, were used and not returnable, so they became the "perfect" material to allocate to this workbench.

This bench measures 25-by-87-by-48-in. high, and is made from a combination of the rough-sawn planks and some 4x4 stock for the legs. The planks make up the top and shelf, and the supports are ripped down plank sections.

1. Determine footprint of your workbench, which means determining the Width x Length x Height.

2. Check the floor level in the area where the front legs will sit. Are they level or will the legs be different heights? Make a note and put aside for later.

3. Cut the bench-top planks to length and rip them for even spacing. The benchtop planks were ripped so three boards fit evenly



This rustic wooden bench was built from rough-sawn 2x10 planking and 4x4 stock.

THE WORLD'S TOUGHEST WIPES



BIGGER AND STRONGER

Soaked in our proprietary 9-cleaning-agent formula, these extra large 10" x 12" wipes are built to withstand vigorous scrubbing and your toughest messes.

TOUGHER

Knocks out dried paint, grease, tar, ink, food and drink spills, scuff marks, dirt, and other tough messes.

Look for Tub O' Towels® at leading retailers, including:

O'Reilly **AutoZone**

LOWE'S **ACE**

Do it Best **True Value**

tubotowels.com

©2014 Federal Process Corporation. All rights reserved.

THE PERFECT WORK-BENCH



The strongest benches are always supported by the table legs from beneath the top. The top of the rustic bench is supported by 2x3 boards every 16".

up against the horizontal beam of our post-and-beam building. The bottom shelf ended up deeper because it extends to the outer wall.

4. Rough-cut the shelf planks and put aside. Rough-cutting means leaving them 3 to 4 inches longer than you need.

5. Cut the 4x4 legs and put aside, the legs will sit directly under the bench-top planks. If the legs won't be sitting on a level surface, keep them longer than the height of the finished bench to trim later. Determine how far your bench-top will overhang your frame supports. You may want to consider vise clearances.

6. Rip the remaining plank stock into 2x3 boards for the support framing of the top and shelf.

7. Cross-cut four 2x3 long supports for the benchtop and shelf. Then, cut enough short supports to install them every 16 inches on center for strength and rigidity. (On this table the long supports are 72 in. and the short supports are 22-1/2 in.)

8. Determine shelf height.

9. Assemble the bench-top support and shelf support frames with using 3-in. galvanized decking or other structural screws.

10. Draw a level line on the wall and mount both frames into the wall

TRIPLE-DECKER STORAGE

For some easy and economical utility shelves, these three plywood shelves are supported by ladder brackets. Each bracket is constructed of two 2x2 legs bridged by three 2-ft. long 2x2 cross-braces. The cross-braces of the brackets are 2 feet apart, but you can customize the height of the shelves. I assembled the brackets using triangular gussets fastened with a combination of Gorilla Glue and wood screws to anchor each intersection of the cross-braces. Use a square to make sure you're assembling the brackets at 90 degrees. And measure between each corresponding cross-brace on each leg to ensure the braces are evenly spaced so the shelves sit flat. You can strengthen the shelves' stability by driving 3-in. screws through the 2x2 brackets and mounting them to wall studs, then adding the plywood. Or, for freestanding shelves, screw 1/4-in. luaun backing onto the legs at the rear to add structural rigidity.



studs with two 3-inch screws every 12 inches. Use temporary scrap wood supports if needed.

11. Clamp the legs to the level frame again and mark for notches. If the legs aren't level, this is the time to cut them. Notch the two outer 4x4 posts to accept the 2x3 support frames. Use a miter saw and handsaw to accomplish this.

12. Dry-fit the 4x4 posts to the outer edge of the support frame. Check for level and plumb, adjusting as needed.

13. Drill 5/8-in. pilot holes through the 4x4 posts and frames. Insert 1/2-in. carriage bolts with washers through the 4x4s and frame supports on the two outer legs. Tighten and check for level as you do this.

14. Measure the shelf support and determine how much overhang, if any, you want to see on your shelf.

16. Cut shelf planks and install with 3-in. screws into each 2x3 support. Use a hand saw or jigsaw to notch the shelf planks around the 4x4 legs. (Install these before the top planks for easier access.)

17. Install the top planks next, in the same manner.

18. Position the bench in your workspace and use it for all your projects.



It is critical that a workbench sits level, which means the legs may need to be cut at different heights if the floor isn't level.



Note that the legs are notched to carry the weight of the support frames of the shelf and top.

Keeps Paint Out. Keeps Lines Sharp.®

FrogTape® is the only painter's tape treated with PaintBlock® Technology. PaintBlock® forms a micro-barrier that seals the edges of the tape, preventing paint bleed. Visit FrogTape.com to see PaintBlock in action, get painting tips and more!

FROGTAPE
Keeps Paint Out. Keeps Lines Sharp.

FrogTape.com
877-FROGTAPE
(376-4827)

©ShurTech Brands, LLC 2015/52287

THE PERFECT WORK-BENCH

HOT PRODUCTS FOR THE GARAGE & WORKSHOP



OVERHEAD STORAGE WITH SAFERACKS

SafeRacks is a premier provider of overhead garage storage, offering high-quality ceiling racks designed to utilize wasted space in your garage. SafeRacks offers nine different size racks, but the most popular is the 4x8. The 4x8 SafeRacks can hold up to 600 lbs. and can be installed down from your ceiling up to 45 inches. With each size storage rack, choose from three different types of dropdown lengths (12-21 in., 18-33 in., 24-45 in.) to customize the height to fit your garage and storage needs. SafeRacks are designed to be installed into wood joists in your ceiling, enabling installation almost anywhere in their garage since it does not have to attach to any side walls. SafeRacks also offers accessory hooks that attach directly to the rack so that you are able to hang items such as bikes, strollers, chairs, rakes, umbrellas and much more. Visit www.saferacks.com.

SEAL-KRETE EPOXY PAINT

Give your garage a showroom finish with Seal-Krete epoxy paint. Painting your garage floor with epoxy paint can provide a tough, durable finish that protects it from oil, gas, antifreeze and salt, and keeps your garage looking great. As with any painting job,



surface preparation is key to a long-lasting finish, so take your time and follow the manufacturer's instructions carefully, such as allowing appropriate dry time between product applications. Once you have your floor completely clean and etched, you can apply a concrete bonding primer. Primer is recommended in order to get maximum adhesion from your paint. Epoxy paint is easy to apply with a brush (for cutting-in along walls) and a roller. Most one-part epoxies recommend two coats to get the best looking and longest lasting floor. For additional protection, you may decide to seal your epoxy floor with a clear sealer. Add a non-slip additive when applying sealer to provide a slip-resistant finish to your top-coat. Seal-Krete has a full line of products for your garage floor. Visit www.seal-krete.com.

STRIKER PARKING SENSOR

The Striker Parking Sensor is designed to take the guesswork out of parking a car in tight garage spaces. It features ultrasonic range-finding technology to accurately locate a vehicle within the desired parking constraints. The Striker Parking Sensor is conveniently equipped with a range selector, making it easy for the user to pick different parking distances from the garage wall. The base unit can be mounted on the wall in front of the car at bumper level. Then, the signal light is mounted in a position easily viewed from the driver's seat. As the driver approaches the parking sensor, they will see a green light indicating that it is safe to proceed. As the car nears the sensor, a yellow light will illuminate as a warning to slow down. Finally, when the car is in the desired parking distance from



Why turn one job into two?

Do it the HYDE® way.

For most sanding projects, your job is not over when the sanding is done. But with the HYDE® Dust-free Sponge Sander, you can sand drywall, wood, or metal without the messy clean up.



For a better finish, start with HYDE.®

hydetools.com • 800-872-4933

Photo: Inc. All rights reserved.

THE PERFECT WORK-BENCH



the sensor, a red light will illuminate, signaling the driver to stop the car. It's easy to install and comes complete with all mounting hardware, instructions and warranty. Visit www.strikerhandtools.com.

GET ORGANIZED WITH SCOTCH FASTENERS

To help organize your garage and workshop, 3M's Scotch Brand offers a line of home fastening and mounting products, including the new Extreme Fasteners. These

new hook-and-loop style fastening strips lock three times stronger than Velcro Industrial Strength Fasteners, and they're designed to withstand even the harshest conditions once the adhesive backing is bonded, including rain, mud and dirt. The Extreme Fasteners feature 3M Dual Lock Technology that click together to secure heavy-weight items up to 10 lbs. in place. Extreme Fasteners can be used to secure under cabinet lighting, hang a birdhouse outside, hold a toolkit or other heavy object on the wall, and much more.

The Scotch Garage Organizer Bundling Strap is an ideal accessory to keep the clutter off your garage floor. Hang up to 20 lbs. using the heavy duty strap and steel construction bracket.

The Scotch Handle Strap Scotch secures bulky loads up to 15 lbs.

for easy grab-and-go transport and storage. It comes with a 36-in. strap, and the the easy-grip handle features a slot for hanging on hooks, nails or pegboard. Visit Fasteners.Scotchbrand.com. **EHT**



Garage Overhead Storage Racks



- Fits Any Garage
- Friendly Service
- Lifetime Warranty
- Do-It-Yourself Kits



Summer Special!
25% Off
Online Orders Only
 Limited One Use Per Customer
 Expires: 09/30/14 Code:EXT714HTMG

877-257-1537
 Scan to Visit SafeRacks.com



SafeRacks is Installed by Licensed and Insured Contractors...Accept no Substitutes, Make Sure it's the Real Thing. U.S. Patents D553,401 / 7,357,262 / D697,785

THE HEAT IS ON!



QUIETwarmth®

RADIANT HEAT FILM FOR FLOATING FLOORS

- Floating radiant heat panels ideally suited for floating tile, laminate and engineered wood flooring.
- World's easiest radiant heat system to install, uses no thinset or self-leveling mortar.
- Designed with recommendations from flooring manufacturers.



global products L.L.C.

(888) 379.9695 quietwarmth.com



Heat your
FLOOR
for
PENNIES
a day!





INSTALLING A CUPOLA

Top Off Your Roof

I love the look of cupolas, and this article will show you how to install a decorative cupola on your roof. I first had the opportunity to rebuild an 80- to 100-year old cupola in historic Concord, Massachusetts, and have since repaired several other cupolas of varying styles.

WHAT IS A CUPOLA?

A cupola can be a decorative or functional architectural structure mounted on top of a home or barn and usually centered along the roof ridge line. In my neck of the woods all barns worthy of their salt have a functional cupola. When functional, a cupola is used to ventilate a building or roof area. They are often made from wood, copper or composite materials. They can come as a single piece or, if larger, two or three pieces.

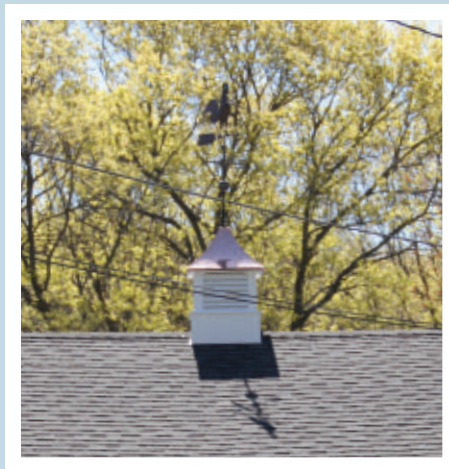

Cupolas of various styles were integrated into English domestic architecture during the late 17th century and became part of the U.S. architectural design during the post-Revolutionary Federalist era. Many new homes use decorative cupolas as architectural details to enhance the exterior design.

A decorative cupola differs from a functional cupola in that the roofing material and roof sheathing does not need to be cut away to create a vent hole. These types of cupolas should be installed with step flashing to prevent leaks.

The decorative cupola in this installation was built by a company called Walpole Woodworkers.

Cupolas generally have three major components: the base; the louver vents or windows; and the finial or weather vane.

By Rob Robillard



First step is to determine the cupola location. If the roof is longer than your tape measure, pull two tape measures from opposite ends and determine where the centers of the two tapes meet.

Remove only the roof ridge shingles where the cupola will be located.

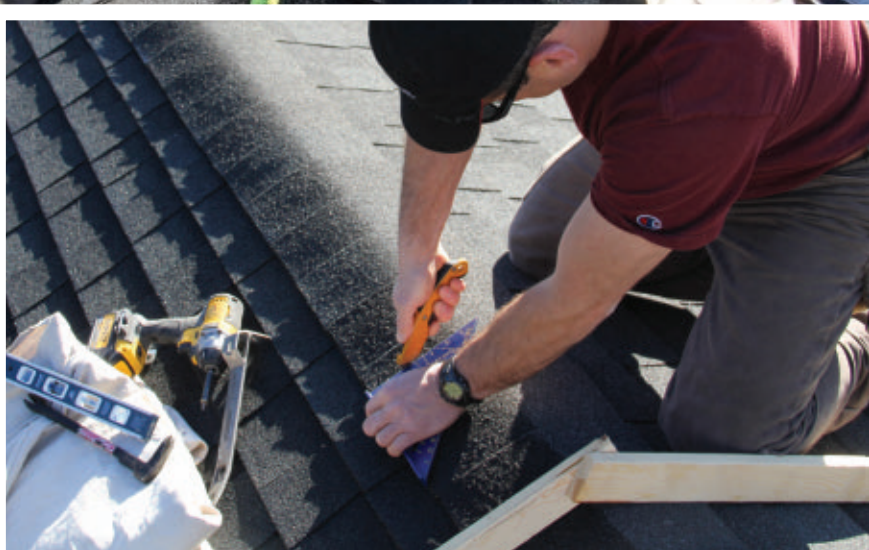

HOW TO INSTALL A DECORATIVE CUPOLA

First step is to determine the cupola location. Measure and mark the center of where the cupola will be installed. If the roof is longer than your tape measure, pull two tape measures from opposite ends and determine where the centers of the two opposing tapes meet.

Measure left and right along the ridge line to determine the outer sides of the cupola.

Remove only the roof ridge shingles. I cut the center shingle out and then used a nail puller (cat's

paw) or a flat bar to remove the roofing nails and ridge cap shingles. The goal is to remove them in one piece so you can use them later for patching, if needed.

Cut and remove only the ridge shingles and/or ridge vent up to the outer edge of where the cupola will sit.

You may need to use the utility knife to trim the shingles back. Use care not to expose the roof sheathing. If you do you will need to patch this spot with rubber flashing tape or flashing and shingles to prevent water intrusion.

DETERMINE THE ROOF PITCH

On the ground, insert one screw into the ends of two 24-in. pieces of wood to make a hinge tool to copy the roof pitch. Bring this angle finder up to the roof and lay it over the area where you removed the ridge shingles.

Press the angle finder tightly to the shingles and then insert a second screw to hold it tight, locking the angle in place.

Once this is complete, use a level to mark a plumb line from the center of the ridge onto your



www.ProNetwork.com



Where do you stand?

ProNetwork will help you lead the way...



Marketing Tools

- Receive leads to qualified homeowners in your area
- Create personalized window remodeling presentations



Exclusive Training

- Online installation and business training
- Live on-line and on-site training



Valuable Rewards

- Earn points for training and purchases
- Use points for over 50,000 items



Why not sign up today?

Becoming a member of the Simonton ProNetwork is absolutely **FREE** and **EASY**.

Log in or join now to be entered in this month's Great Golf Give away.

See rules at www.ProNetwork.com.

Log in or sign up today at www.ProNetwork.com, provide your number to your favorite distributor to enter into EPOPS and start earning valuable points today.

INSTALLING A CUPOLA



Use two pieces of wood to make a hinged angle finder. Use the angle finder on the roof ridge to determine the pitch.

The cupola is made from composite material and arrived as a single piece.



angle finder. This plumb line will be your top reference line when tracing the cupola. Bring your angle finder off the roof to the cupola to be installed.

MARK THE CUPOLA BASE

Determine which sides will be the front and back of your cupola.

Measure and draw a center-line on the two opposing base walls on your cupola. These are the two sides that will straddle the roof ridge.

Using your angle finder, line up your plumb line on the center line and ensure that the bottom legs of your angle finder line up at the lower corners of the cupola. Doing this will ensure an accurate and symmetrical cutout.



Determine how the cupola will be oriented on the roof so you cut the correct sides to match the pitch.



Mark the centerline on the cupola and align the angle finder.



GUTSTER™
DEMO-BAR
Demolition Made Easy

...Putting a New Spin on Demolition



**You Need To See It
To Believe It!**

www.thegutster.com



Scribe the roof pitch onto the cupola. Cut the angle with a jigsaw.



Bring the cupola to the roof and test the fit.



Shown is the cut base. If you have a steep roof, greater than 9-12 pitch, you may need to install an extended base. Cut the opposite side of the base to match.



Use the ridge shingles that you removed, if in good condition, to make any necessary patches or to cover any roofing you removed.

Mark both sides of the cupola the same way and use a saw to cut out the angle along your marked lines.

If you have a steep roof, greater than 9-12 pitch, you may need to install an extended base.

MOUNTING BOARDS

Mount four sections of 2x4 blocks on the roof to fit flush inside the edges of your cupola. Pre-drill your holes in the block and apply silicone to the bottom of each block prior to attaching it to your roofing.

Mount all four blocks to the roof sheathing and drive the top fasteners into the ridge board.



Pre-drill holes in the 2x4 mounting blocks and apply silicone to the bottom of the prior to attaching them to your roofing.

TOUGH Rugged, Rip it, Stick it, Done **TAPE**



Made in USA 

With its double-thick adhesive, heavy-duty cloth backing and rugged outer shell, Gorilla Tape sticks to rough, uneven and unforgiving surfaces. It's Gorilla Tough, every time.



**For the Toughest Jobs
on Planet Earth®**

www.gorillatough.com

©2014 The Gorilla Glue Company

Kick the **ICK**



Easy and Affordable

Smart **SINK** Stopper[®]
Recyclable Hair Trap...and More!



BUY 1 & GET 1 FREE!
PROMO CODE:
EXTREME
Limited offer.



HALF TWIST & THAT'S IT!

- ✓ No time consuming mess
- ✓ No hazardous chemicals
- ✓ No more lost items
- ✓ No looking for tools

EASY "DIY" INSTALLATION!

DrainFixt LLC
Smart Plumbing Solutions...Made Simple!

www.drainfixt.com

INSTALLING A **CUPOLA**

POSITION THE CUPOLA ON THE ROOF

Once you are satisfied with the fit on the roof, attach the cupola with two to three stainless steel screws driven into each mounting block. Plug or patch the screw holes. On PVC cupolas, I use the Cortex screw and plug system.

Apply silicone only to the seams that straddle the ridge and are

fastened to the mounting blocks. This will keep angled rainfall from getting under your cupola and affecting the 2x4 wood.

Leave the lower pitches' roof edges open to drain any wind driven snow or moisture that may make its way under the louvers.

Use the ridge shingles that you removed, if in good condition, to make any additional patches or to cover any roofing you removed. **EHT**



Mount four sections of 2x4 blocks to fit flush inside the edges of your cupola. Drive the top fasteners into the ridge board.



When mounting the cupola, apply silicone only to the seams that straddle the ridge and are fastened to the mounting blocks.



Attach the cupola with two to three stainless steel screws driven into each block.



Sometimes it's what you don't see
That makes a deck beautiful.



Performance,
Durability,
Easy to Install,
Versatility . . .
A Strong and Secure
Concealed Deck
Fastening System



Sure Drive USA® | Conover, NC & Hayward, CA | 800-951-2222 | www.suredrive.com

Upgrading a stripped-down utility trailer to move mulch and tow your tools.

TRICK OUT YOUR TRAILER

By Mark Clement

I'm a trailer guy. Yes, a dump truck would rock for heavy haul-outs, and a big box truck would be great for storing tools and serving as a mobile workshop. But, depending on the day, the work we do may range from residential bathroom improvements to our Food Network bakery make-overs. We may also tackle a weekend DIY project like hauling mulch and a mower to a friend's house. This variety of jobs requires the flexibility a trailer offers.

We can also leave a trailer at the jobsite and just drive the truck by itself, which isn't possible with the aforementioned vehicles. Part FedEx, part dumpster, all workhorse, our trailer sees no end to its work ... or play, for that matter. A utility trailer is a king vacation machine, too. Forget about jamming everything you own into the SUV. Put the bikes, beach blankets and Beanie Babies in the trailer and ride in style.

If all you have is the common 16-in. tall angle-iron trailer body, you're limited to how much you can get in and out of a simple utility trailer. That is, unless you add to it.

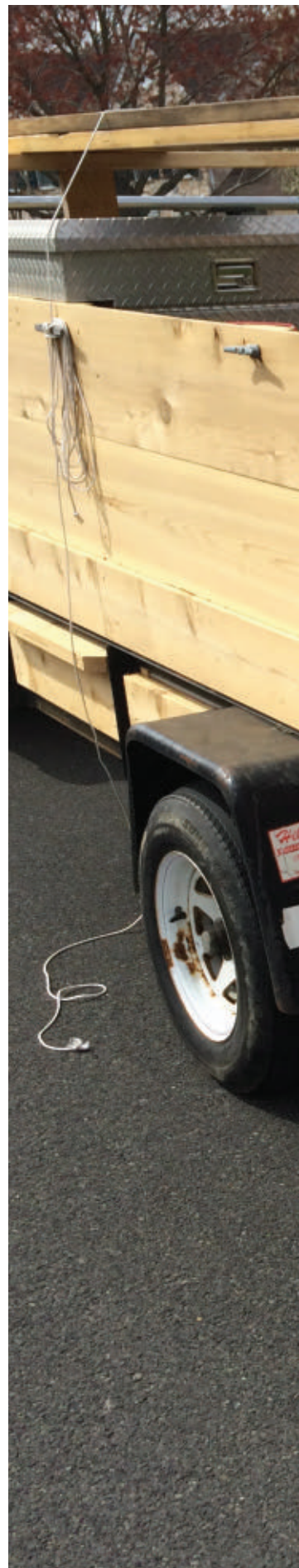





A basic "no walls" utility trailer is the platform. Sure, it can carry some stuff, but will get left in the dust by a trailer tricked out to roll with all your building equipment.

TOOLS AND MATERIALS

Obviously, you'll need a trailer. Mine is a 5-by-10-ft. two-wheel utility trailer. Nothing fancy, yet.

The upgrade shown in this article requires 2x material for the posts and materials racks, 1/2-by-3-in. galvanized through bolts, 3-in. deck screws, and 1x or 2x material for the walls. You'll also need a drill and bits to drill out steel and a saw to cut stuff.

THE BUILD

First, cut the posts or staves. My trailer walls are about 40-1/2 inches tall. It's a great height for

everything I carry. I fill in the trailer framer around the wheel wells, then stack four 2x8s for the walls. I've made the staves from 2x4 in the past, but I beefed them up in this build to 2x6 pressure treated pine because I knew I'd be lashing loads to the top of them. (More on that later.) Also, install the vertical staves 'wild' and cut them to final length later.

You'll need to drill bolt holes through the trailer frame to mount the staves. Here's a tip for drilling steel that makes the job easier. First, locate the hole. Next drill a pilot hole with a small (1/8-inch),

very sharp bit that is designed to drill steel. Once the pilot hole is drilled, follow up with the right diameter bit, in this case 5/8-in. to accommodate a 1/2-in. bolt.

Use a drill to drill the holes, not an impact driver. Steel likes to be drilled more slowly than wood, so an impact driver might not perform well. Some people drip oil on the bit to keep it lubricated and cutting well.

Once the holes are drilled, square up the staves to the trailer body, then hold them fast with a couple of bar clamps. Drill through the steel and through the wood. Pop in the through-bolts and hand-tighten the nuts before socking them tight with a socket set or impact wrench.

I center all but the end and corner staves on the trailer's steel posts to make fastening the planking to the staves easier later on. It also gives the through-bolts the maximum meat to hold onto for heavy loads.

Next, install the planking. To make life easier I span the trailer's wheel well with blocking on the inside of the trailer, installing the boards flush with the staves. To make the butt-joint connections between the boards set edge-to-edge, I make what I call "no-jig pocket holes". I drill angled pilot holes large enough and deep enough to countersink the screws. This makes driving toe-screws much easier than any other method I've tried. For the oddball angles by the wheel well, I used



Durable Steel Edging is Easy to Shape and Install

*The Professionals Choice
for Edging that's Affordable
and a Long-Lasting Solution
for Do-It-Yourselfers*



AMERICAN MADE. AMERICAN STRONG.

- Provides a clean separation
- Rigid enough for straight lines
- Flexible for free contoured shapes

Durable Powder Coat Available in Green, Brown and Black



www.colmet.com

© 2014 COLLIER METAL SPECIALTIES LTD

Ask for our quality Col-Met products at your leading home and garden centers!

TRICK OUT YOUR TRAILER

the Starrett ProSite Protractor—love that thing—to lay out the angles.

Next, I start at the back and work my way around, piecing in

all the small pieces and ripped blocking to create a solid wall on the trailer frame. It gives me peace of mind hauling, well, everything.

I used 2x pressure-treated pine for the planking on this trailer upgrade, and it is virtually bomb-proof. But 2x is heavy making the trailer hard to move around by hand. If I had a tractor or ATV, that wouldn't be a big deal, but I don't. Another option would be to use 1x12 #2 pine. I formerly had a trailer built with 1x12 and not only was it much lighter, it lasted for

RYOBI **Lithium 40V**

BRUSHLESS MOTOR
OPTIMIZED TO PROVIDE
GAS-LIKE POWER

NEW
20" Brushless Mower

NOW WITH

RYOBI FIVE YEAR LIMITED TOOL WARRANTY

Learn more at www.ryobitools.com



Cut the staves to support the wall. A 2x4 will work, but I beefed them up to 2x6 because I knew I'd be lashing loads to the top. Also, if you move a lot of debris or mulch then beveling the edges of the stave makes the trailer easier to clean out.



When drilling metal, drill a small pilot hole with a very sharp bit

nearly a decade of professional use. Bottom line: your call.

To get the first course of planking started on my trailer where there are interruptions from the



The pilot hole makes drilling the full-diameter hole much easier.



Clamp the stave square to the trailer frame and drill the hole for the through-bolt.



Square the staves to the trailer and insert the through-bolts. Use cut washers on both sides and tighten with a socket or impact driver. Tighten until the washer crunches into the wood fiber. If you're using new treated wood with high moisture content, check the connections again in a week and re-tighten as necessary.

wheel wells and corners, I used a couple of bar clamps to hold the pieces where I wanted them before bombing in the screws.

To make the look interesting, I like to alternate the corners. I

think it makes the corner stronger but I also really like the box-joint, custom look.

Every now and again a 3-in. deck screw tip makes it through the laminated 2-bys (which is 3

THE BEST PORTABLE TOOL STORAGE AVAILABLE



**Water
Resistant**

Lockable

**Rolls
Anywhere**

Stop Lifting and Start Rolling!

- High volume tool storage and transport
- Takes the work out of carrying tools and parts
- Double wall polyethylene durability
- Store - Lock - & Roll tools and supplies to the job **IN ONE TRIP!**



1-800-KADDIES (523-3437)

WWW.KADDIES.COM



<p>14" DELUXE BANDSAW</p> <p>ANNIVERSARY EDITION</p> <p>CAST IRON WHEELS</p> <p>MADE IN TAIWAN</p> <p>G0555LANV \$545.00</p> <p>SALE \$525.00</p>	<p>17" 2 HP BANDSAW</p> <p>ANNIVERSARY EDITION</p> <p>Reviews & Awards</p> <p>MADE IN TAIWAN</p> <p>G0513ANV \$895.00</p> <p>SALE \$825.00</p>
<p>10" HYBRID TABLE SAW W/ RIVING KNIFE</p> <p>G0715P</p> <p>ONLY \$795.00</p>	<p>10" WET GRINDER KIT</p> <p>ANNIVERSARY EDITION</p> <p>Reviews & Awards</p> <p>DESIGNED IN GERMANY</p> <p>T10010ANV \$199.95</p> <p>INTRODUCTORY \$159.95</p>
<p>3/4 HP SHAPER</p> <p>INCLUDES 1/4" & 1/2" ROUTER BIT ADAPTERS</p> <p>G0510Z \$425.00</p> <p>ONLY \$395.00</p>	<p>12" BABY DRUM SANDER</p> <p>MADE IN TAIWAN</p> <p>G0459P \$695.00</p> <p>SALE \$575.00</p>
<p>15" PLANER W/ MOBILE BASE</p> <p>3HP MOTOR</p> <p>G0453P \$1125.00</p> <p>ONLY \$1025.00</p>	<p>8" X 72" JOINTER W/ MOBILE BASE</p> <p>3HP MOTOR</p> <p>G0656 \$845.00</p> <p>ONLY \$795.00</p>

PLEASE VISIT GRIZZLY.COM* FOR COMPLETE DETAILS & SPECIFICATIONS

FREE CATALOG

760 PAGES
HUGE SELECTION OF HIGH QUALITY MACHINES & TOOLS AT INCREDIBLE PRICES

VIEW VIDEOS AT grizzly.com

PRICING CODE 14EXTREME
RELATION THIS CODE WHEN PLACING YOUR ORDER 16392

1-800-523-4777

grizzly.com

TECHNICAL SERVICE: 570-546-9863 FAX: 800-438-5901

TRICK OUT YOUR TRAILER



I span the trailer's wheel well with blocking on the inside of the trailer, installing the boards flush with the staves.

inches thick). It's hardly a hazard unless you're just crushing the heads into the wood and the points are really showing, but I blunt them with a hammer whack anyway. I've been cut, scraped and scratched by everything else. What would make these screw tips any different?

MATERIAL HANDLERS

While the hero function of most trailers, including mine, is to hold stuff inside the walls, there's no reason you can't rack 'em up to carry the long stuff like ladders, lumber or molding.



Add blocking as needed to create a wall around the trailer's angle iron projections.



For mapping out the weird wheel well angles I used one of my fave tools: the Starrett ProSite Protractor.



Get the first course of planking started. To hold the pieces tight if you're working alone, a few bar clamps can be your best friend. Lock 'em and sock 'em.

To get a really cool, powerhouse look, I alternated the corners to create a kind of box joint.



Once you've planked up the sides, cut all the staves to length except the front and back, which will be vertical supports for the materials racks.

got dust?

We've got the solutions.

Super Dust Deputy®



- An affordable alternative to replacing your existing 1.5 - 3hp single stage dust collector.
- Captures 99% of the waste before it reaches your collector.
- Keeps your filter cleaner, keeps your air flow consistent with no dusty bags to empty.

Pat. # 7,282,074 / Design Pat. # D703,401

"I received the **Super Dust Deputy** and all the other items in great shape. I got everything hooked up in our new shop and **WOW**. I can't believe how well the duct system works with the new **Super Dust Deputy** combined with our old dust collector. Almost nothing is getting to the collector. It all goes right into the drum under the cyclone. **It is AWESOME!** Our dust collection system is 100% better because our filters stay cleaner longer and we are not emptying the old separator nearly as often. We have been running in our new shop for almost a week and there is almost nothing in the collector bags. **AMAZING!**"

Dave Eilers
www.davescustomservices.com



Dust Deputy®

Captures 99% of the dust before it reaches your vacuum's filter.

- ▶ Retrofits to any shop vacuum.
- ▶ Pays for itself in filter replacement costs alone!
- ▶ Helps maintain suction.
- ▶ Easy to empty bucket.

Deluxe Dust Deputy®

Pat. # 7,282,074

Call Today for Information!

1.800.732.4065

www.oneida-air.com



Dust Collection Since 1993.

TRICK OUT YOUR TRAILER

The material rack on my trailer is fixed to the staves (which I didn't cut flush with the trailer walls) but kept at 53-inches above the trailer deck so it would clear the trailer's tailgate. It's a T-bracket of 2x8 that bridges the staves.

The end of the rack is also a T, but I fabricated a pocket for it to sit in so the



Blunt any screw tips that make it through the laminated 2-bys.

Make and install the materials handlers, aka 'racks'.

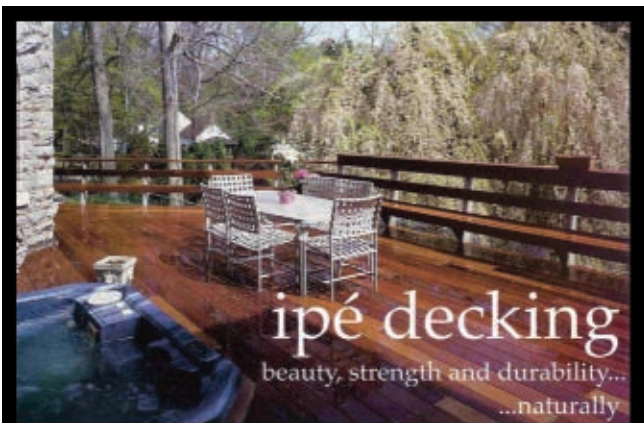

The full line of ipé decking, Ultra-Tec Cable™ systems, Deckorators™ products and Aurora Deck Lighting are all available directly at Bristol Valley Hardwoods. (or ask your architect or contractor to contact us)

Bristol Valley Hardwoods

800-724-0132

Visit our website at www.bristolvalley.com

For a free sample package of our ipé woods mention code 5695.*
*shipping additional

DECK2WALL™
spacer
DECK LEDGER SPACERS
**DON'T LET YOUR DECK
ROT YOUR HOUSE!**
IAS Accredited Lab Tested
Now available in 2 sizes
Original spacers for bolts and lags
NEW **SWS** spacers for **Structural Wood Screws**
Fastening Tables Available
Faster, Easier, Stronger Connection than
Washers - Visit website for details



DECKS UNLIMITED
Toll Free 888 577-2237
www.deck2wallspacer.com
US PATENTS
6,945,004 AND 8,087,207

Ledger Connection Protection™

EXTRA FEATURES

As much use as I get out of this trailer trick-out, I added some details (and would like to add more) that max it out even further.

TOOL HOLDER. I added a triangular front piece on the trailer tongue to hold shovels and other long-handled tools. The triangular shape makes this wall of the trailer a little more aerodynamic for easier towing.

CLEATS. I added six cleats like you'd find on a dock or ski boat as anchor points for quickly cinching and un-cinching loads using rope. From tarps to lumber, these are essential (and cheap) additions for me. I use bowline knots and trucker's hitches to secure the material.

TRUCK BOX. I also added a few blocks inside the trailer walls to set my old truck box on. When I roll to a job-site, I can store any number of tools in there. For vacation, it's awesome for anything from beach toys to beer and ice or grocery store stuff you want to bring.



ENTER "EXTREME" AT CHECKOUT FOR 10% OFF!

Power Planter®

INTRODUCING
The New **207**
POWER PLANTER

Plant 4 & 6 pack annuals
in containers and beds
fast and easy

100% Made in the USA

www.PowerPlanter.com

(217) 379-2614

Silicone
X-TREME TAPE®

The Ultimate Protective & Repair Wrap
Fix & Seal Anything, Anywhere, Anytime



- Won't Melt to 500°F (+260°C)
- Remains Flexible to -60°F (-50°C)
- Insulates to 8000 Volts (per unstretched layer)
- Stretch Seal
- Air & Water Tight
- Better than Duct Tape

MOCAP® 
800.633.6775
Order Online: www.xtremetape.com

TRICK OUT YOUR TRAILER



Marine cleats are the world's best tie-down anchor. I have 3 on each side of the trailer with 3/8" nylon braided line as my tie-down material. To make the rear cross-piece removable, I fashioned a slotted pocket out of scrap 2x6 that holds the leg of the T-shaped rack.



T is removable. The reason for this is that a horizontal rack gets in the way when hauling tools, mulch, or plaster debris. In other words, if I made it a fixed-feature I'd literally have to duck under it every time I walked into the trailer with a sheet of drywall.

So whether I'm hauling for work or hauling out of town for vacation (who am I kidding—vacation?), my stuff is safe and secure for the long haul. **EHT**

Editor's Note: Mark Clement is co-host of the MyFixitUpLife show, General Contractor on Food Network's Save My Bakery and spokesman for Wood Naturally.

NEW

Introducing
Starrett, Starrett Exact and Starrett Exact Plus



What company always measures up?

Starrett®
Innovation Rules



See the entire new hand tool line!
www.starrett.com



starrett.com



WEATHERSTRIPPING

For your home, barn and garage

- Effective air seal
- Won't crack or tear in extreme temperatures
- Perfect for uneven surfaces
- Durable – won't degrade over time (may last the life-time of your door)
- Deters pests – a physical barrier, blocking light and odors that attract pest



BRUSH WEATHERSTRIPPING for HOME & GARAGE is energy-efficient, environmentally-friendly and can reduce heating and cooling costs. It's ideal for all types of doors: Entry, Garage, Barn, Hangar

 **BRUSH**Weatherseal.com

brushweatherseal.com | 855.225.8892

Join the Fan Club

How to Install a Ceiling Fan



By Matt Weber

A ceiling fan can be a stylish and effective way to enhance airflow throughout a room. Unlike swapping one light fixture for another light fixture, however, a ceiling fan requires special mounting accommodations to support its weight and movement.

A ceiling fan requires a metal ETL-listed mounting box, and if there is not one already in place, then one must be installed before hanging the fan. The fan's outlet box must be secured directly to the building framing with the appropriate fasteners to provide sufficient reinforcement to support

the moving weight of the fan (at least 50 lbs.).

Never mount a fan using a plastic outlet box. The fan could feasibly tear out of the plastic mounting and fall onto whoever or whatever happens to be beneath it.

In this article I show the steps to install the Kichler Décor Innes II ceiling fan. Although assembly will vary among different models of fans, the mounting procedure is basically the same for all ceiling-mounted units.

INSTALLATION

Begin by shutting off power to the ceiling fixture at the electrical

On this project we installed the Innes II decorative ceiling fan from Kichler.



After removing the old light fixture, I discovered the old plastic ceiling box was not suitable to mount the new fan.



www.betterwayac.com

INGRAM'S
WATER & AIR EQUIPMENT

**NOW
OFFERING
COMPLETE
SOLAR
KITS!**

Guaranteed Lowest Prices!



HEATING & AIR CONDITIONING:

Air Conditioners, Geothermal Heat Pumps, Split System Heat Pumps and more!

WATER EQUIPMENT:

Water Softeners, Water Coolers, Faucet Mount Filters and more!

AIR PURIFICATION:

Electronic Air Cleaner, Low Micron Media Filter, Humidifiers, Portable Air Units and more!

INGRAM'S OFFERS:

FRIENDLY SERVICE.

We are a friendly, family-owned business that enjoys getting to know our customers. Your concerns have our utmost attention.

LOWEST OUT THE DOOR PRICE.

We guarantee to have the lowest out the door price. This is after shipping cost, special handling fees, insurance, and etc.

FAST SHIPPING.

All HVAC shipments are easily monitored from our door to yours. We strive to save you additional money on freight cost, call us for the lowest available shipping quote.

Save Up To \$500 With
Our Industry Exclusive

PRESSPLAY
REWARDS

Call us **1-800-360-1569**

Visit us **BetterwayAC.com**

service panel. After removing the old light fixture and disconnecting the wires, I had to deal with an old plastic ceiling box that was not rated for the fan.

To dislodge the plastic box, cut away any caulk or paint around the rim, try to remove the screws or nails and pry it out. This didn't work in my case, and I had to

venture into the attic to pry some nails out of a ceiling joist to remove the old box.

The good news about the ceiling joist is that it provided a solid framing member on which to secure the new ETL-listed fan box. You'll find the appropriate metal boxes prominently listed as "fan-rated" on the packaging at your local home center. The one I used came with a 90-degree bracket

SWANSON
Est. 1925

THE TWO MOST INNOVATIVE TAPES BY ANY MEASURE!



GRIP
ROUNDED EDGES
The SAVAGE[®] Gripline™
Grips rounded edges, vertical and angled surfaces with a patented rotating tip.

SEE ALL IT CAN DO!
SCAN HERE





SCRIBE
STRAIGHT LINES & CIRCLES
The SAVAGE[®] ProScribe™
Scribes straight lines and circles with an exclusive guide and centering pin.

SEE ALL IT CAN DO!
SCAN HERE



VISIT BOOTH #5203 FOR A FREE GIFT!

Visit the **Swanson Tool Booth** at the **2014 Remodeling Show** to see these two revolutionary new tapes and to receive a **FREE** gift when you mention this ad.
swansontoolco.com



It's a good idea to label your wires for reconnection, because once you remove all the wire nuts, you may have a tangle of wires like this to sort through.



Inside the attic I found the old outlet box buried beneath loose insulation attached to the side of a ceiling joist.



The plastic box was nailed to the framing, so I had to pry it loose.

remodeling
SHOW

deck EXPO

JLCLIVE
RESIDENTIAL CONSTRUCTION SHOW

3 EVENTS. 2 DAYS. 1 LOCATION.



EXHIBIT HALL: OCTOBER 23-24 | CONFERENCE: OCTOBER 22-24

BALTIMORE

www.RemodelingShow.com | www.DeckExpo.com | www.JLCLIVE.com

Remodeling Show sponsored by: **NAHB** remodeling
NAHB Remodelers

DeckExpo sponsored by: **NADRA** deck builder





The new metal ceiling fan box came with a right-angle bracket for mounting from the side.

for screwing into the side of the joist.

If the box is not situated beneath or adjacent to a ceiling joist, then you'll need to make other accommodations to mount it securely. If you have access to the ceiling joists, you can install



In my situation, I attached the fan box to the side of the joist using heavy-duty R4 screws from GRK fasteners.

Imagine...
what you could do with this wasted space.

Having the best back yard in the neighborhood is easier than you think!

Under Deck Oasis is America's favorite aluminum under deck ceiling. Our amazing, water-tight system is the best looking and best performing in the country... *Guaranteed!*

Material kits delivered for the "Do-It-Your-Selfer."

Before → After

616.425.8188 • www.UnderDeckOasis.com **UNDER DECK OASIS**

TRAC VAC

Quality Lawn Vacuums, Lawn Equipment, & Lawn Accessories

A vacuum to fit your need, we offer a range of vacuums from **5.5HP mounted** units to **11HP tow behind** units.

For more info call:
Palmor Products, Inc.
 1-800-872-2822 or visit us on the web at trac-vac.com

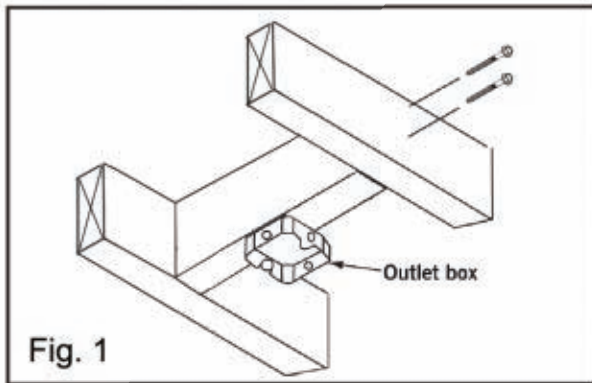

Fig. 1

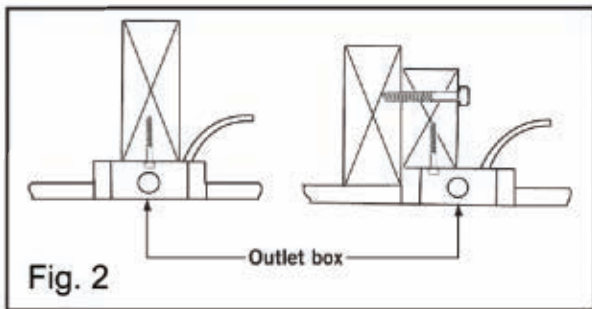

Fig. 2

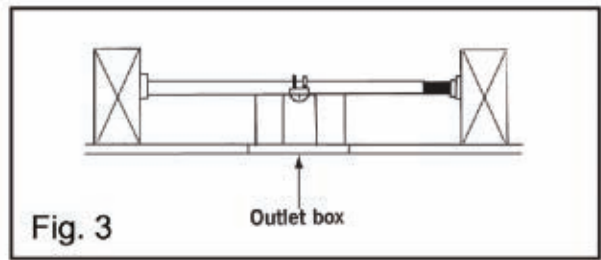

Fig. 3

To hang your fan where there is an existing fixture but no ceiling joist, you can install 2x blocking between ceiling joists or alongside a ceiling joist, and then mount the fan box to the blocking. Or, you may need to install a joist hanger bar as shown in Fig. 3.

EZ PRO®

Perfect Pass

COMPOUND MOLDING TOOL

FINALLY!

Drywall finishing is fast and easy!

As you well know, along with the hours of work applying the compound, comes sanding and the harmful dust that has been a necessary evil when finishing your drywall projects... until now!

With the **EZ Pro Perfect Pass**, the frustration is a thing of the past and sanding is eliminated. Even first-time drywallers can get professional results every time, with **fewer steps** and **less mess!**

PERFECT JOINT EVERY TIME!

NO DUST!

NO SANDING!

NO MESS!

A MUST HAVE!



www.ezprotools.com

PROJECT NEXT

2x blocking between the joists and then screw the fan box into the blocking.

If the fixture is situated between two joists and you can't access the joists from above, then you can install a metal brace called a "ceiling fan brace" or "joist hanger bar". Available at most home centers, the brace can be inserted through the hole in the ceiling. Once positioned between the joists, the brace expands to contact the framing on each side. The fan box mounts onto the brace. Make sure the brace is centered in the hole and at the proper elevation so the fan box will be flush with the ceiling, then use a wrench or pliers to tighten the brace until secure. **EHT**



Route the wires through the punch-out holes in the fan box.



To hide some ceiling damage around the fixture box, I installed a decorative ceiling medallion with a couple of trim-head screws driven into the ceiling joist. The medallion is an accessory trim piece available at most home centers that sell fans.



Models vary, so it's important to refer to your fan manufacturer's instructions for assembling your specific fan. Typically, assembly begins with a mounting bracket that fastens into the metal box.



Because I forgot to label the wires, we had to use a multi-meter to test the cables to determine how to hook them back up correctly. Save yourself some hassle and learn from my mistake.



The next step is to install the motor body. Fan manufacturers usually provide a safety wire or mounting bracket that can hold the motor body in position while you work.



Connect the electrical wires to the fan body according to the instructions included with your fan.



The fan blades are attached one at a time.



If your fan includes a light fixture, it's usually the last component to be installed.



In addition to its sleek, contemporary design, the Kichler Innes II fan includes a remote control with a dimmer feature for the light, three fan speeds and a motor that operates silently.



S15 SPRAY-PRO®

Ground Driven Push Sprayer

Features:

- ✦ SPRAY-PRO® high-speed pump
- ✦ 5gal/22L tank capacity
- ✦ 10" Pneumatic wheels
- ✦ Fully assembled steel chassis
- ✦ 3 Interchangeable nozzles

For information, call 1-800-294-0671 or visit
www.earthway.com to find a dealer.



HOT PRODUCTS

SAKRETE U.S. COLD PATCH

Sakrete U.S. Cold Patch is a high-performance permanent pothole repair product that can be used in wet or dry conditions. Easy to use right out of the package, just place the Cold Patch and tamp or drive over the repair with no tracking. Unlike cutback asphalt, this new product cures through compaction rather than evaporation, so it hardens with each passing car tire. Think of it as "hot mix in a bag". U.S. Cold Patch is environmentally friendly, made with over 95 percent recycled materials and low VOC content, so it requires no special equipment or safety clothing to install. The product causes no oily mess, it's odorless and cleans up with soap and water. Visit www.sakrete.com.



WOLVERINE FLAME RESISTANT CLOTHING

Wolverine has introduced two new styles of Flame Resistant shirts in versatile Twill and Ripstop materials. Both garments are flame resistant and are constructed with flame-resistant fabric, meeting requirements specified in ASTM-F2302-8 for labeling protective clothing as flame resistant. Often worn by electricians who may be exposed to momentary electric arcs, flame-resistant clothing must meet ASTM F1506, the standard performance specification for flame resistant and arc-rated textile materials for wearing apparel exposed to momentary electric arc and related thermal hazards. Wolverine's Flame Resistant clothing meets this standard. The new shirts are available in Grey, Khaki, Blue and Navy (Ripstop shirt also available in Brown). Visit www.wolverine.com.



MOSQUITO DUNKS

Homeowners looking for an effective way to control pesky, disease-spreading mosquitoes don't have to resort to harmful chemicals. Mosquito Dunk kills mosquitoes before they're old enough to bite. The active ingredient in Mosquito Dunk is BTI (Bacillus thuringiensis israelensis), a naturally occurring bacterium that's deadly to mosquito larvae but harmless to other living things. Mosquito Dunk, which look like small beige donuts, float on standing water and naturally kill mosquito larvae before they become adults. Each Mosquito Dunk will treat up to 100 square feet of surface water for about 30 days. Learn more at www.summitresponsiblesolutions.com.



Aerosol Spraying Made Easier!

INTRODUCING

CAN1
GUN1
Spray Can Tool

NRHA
PACKAGING AND
MERCHANDISING
AWARDS
Silver Award Winner

Spray Paints • Lubricants • Adhesives & More

CAN1
Spray Can Tool

Recycled Plastic

MADE IN USA

MEMBER TESTED
AND RECOMMENDED
BY
HANDYMAN
BUY WITH
TOTAL
CONFIDENCE

Exclusive FullGrip™ Trigger
Up to **8x** Easier to Spray
Professional Results

Easy To Use With Gloves
Highest Grip Comfort
Ergonomic Design &
Arthritis-Friendly™

Easy On & Off
Reusable

IMPORTANT: Read
ALL INSTRUCTIONS
ON BACK
BEFORE USE!

UNIVERSAL FIT
For All Standard
Spray Cans

Item # 02012

Patent Pending - U.S. Design Pat. # D592,953

EXCLUSIVE FEATURES:

- ▶ **E-Z Pull FullGrip™ Trigger**
- ▶ **Up To 8X Easier To Spray***
- ▶ **Easy To Use With Gloves**
- ▶ **Fits ALL Spray Cans!** ▶ Reusable
- ▶ **Made In USA** ▶ Recycled Plastic
- ▶ **Suggested List \$3.99 ea.**

Avail. At: Ace Hardware • SKU# 1390657
Lee Valley Tools • P.N.# 27K0690
Tractor Supply • SKU# 1038713

Call Now
800.743.0115



**BUY
WITH
TOTAL
CONFIDENCE**

up to
**8X EASIER
TO SPRAY**

*than other products in this category.



©2010 SafeWorld™ Int'l., Inc. info@cangun1.com cangun1.com

HOT PRODUCTS

STARLIGHT SOLAR-POWERED LED ACCENT LIGHTS

Starlight Solar-Powered LED Accent Lights from AGS Stainless offer an easy-to-install, energy-saving lighting option for any deck or outdoor living space. Starlight is the first solar-powered light designed specifically for cable railing systems. Housed in a stylish yet sturdy marine-grade stainless steel shell, this new exterior lighting accessory nicely complements the full-line of AGS' stainless steel decking/stairway cable rail systems offering sleek, long-lasting elegance at an affordable price. Created as a lighting accessory for a wide-array of exterior settings, the display possibilities for Starlight are nearly endless: mounted upon stainless steel decking posts



within outdoor living spaces, illuminate second-story railings to create depth, front walkway pillars to create a welcoming visual affect, attached to any building's exterior to accentuate focal points. Starlight is the first lighting accessory to the Clearview line of stainless steel railing systems. The Clearview design and ordering process is straightforward and simple: sketches and approximate dimensions are submitted to AGS Stainless where CAD drawing and all details of your system are created by a member of the design team. Visit www.AGSStainless.com.

Weed Razer

The most efficient and effective tool made for removing submerged weeds.

Clears Your Lake or Pond Weeds in Minutes!

Clears a path 48" wide. Returns to you weed free!

Using the Weed Razer is SIMPLE:

1. Give it a toss
2. Let it sink
3. Pull it in
4. Repeat

Purchase Online Using Code JENLIS-440 to Receive Shipping Discounts.

TOLL FREE: 877-356-6455
www.WeedRazers.com

Patent Pending

NU-WAL[®] RESTORATION SYSTEM

Make Walls and Ceilings Like New!

- Cost effective
- One day application
- Remove no trim

RESTORE CRACKED WALLS

SPECIFICATION CHEMICALS, INC.
www.nu-wal.com
800-247-3932

Removable Magna Seal Soundproofing Window

Add a simple soundproof removable window pane.

REDUCE SOUND
in or out!

REDUCE HEAT
in or out!

win.alturl.com
1-888-942-7723

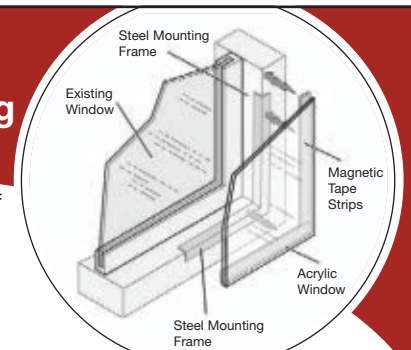

Super Soundproofing[™]
The First Online Soundproofing Resource

SMART, STYLISH SOLUTIONS FROM FYPON



FOR HIGH-QUALITY, LOW-MAINTENANCE POLYURETHANE
AND PVC MILLWORK, FYPON HAS YOU COVERED.

FYPON
It's How You Finish.™

800.446.3040 · www.fypon.com · info@fypon.com

HOT PRODUCTS

NEW FAMILY OF WORM-DRIVE SKILSAWS

When it comes to the high-torque power of worm-drive saws, Skil Power Tools is the team to beat. As the originator of the worm-drive saw, the company's new 7-1/4 In. Magnesium Worm Drive Skilsaw family continues to build on this hard-earned reputation. The lineup includes three saws: the Skilsaw SHD77-02, the Skilsaw SHD77M-02 and the Skilsaw MAG77LT. Each is designed to achieve different cutting applications. The main



feature of the new saws is their reduced weight. Each saw is lighter than its predecessor. The new saws also feature a multi-function wrench that stores on the saw foot for convenience, a new depth-of-cut system for quick and easy adjustment, and a 24-tooth carbide blade. Perfect for heavy-duty framing, concrete forming and masons, the 7-1/4 in. Aluminum Worm Drive Skilsaw is one of the most versatile saws on the market, making it a rugged workhorse on the jobsite. The powerful 15-amp motor and durable worm-drive gears are engineered for pro performance and long life. Visit www.skiltools.com.

BEST BARN'S Large Selection of DIY Building Kits
New You Can Almost Do Best

• Buy Direct • Free Shipping

online catalog available at
www.bestbarnsusa.com
email: info@barnkits.com

PALMSCOPE

The new PalmScope (DCS950) from General Tools & Instruments is the world's smallest full-featured video inspection system. It fits in a pocket or clips to a belt, and the specs rival far more expensive units. It's also a rugged device that's built to survive harsh environments and rigorous tasks. The instrument's clamshell design allows the camera-tipped probe to be coiled safely and conveniently inside the device for storage. Plus, it can be operated with one hand, leaving the other hand free to use tools



and making it ideal for busy craftsmen, contractors and DIY'ers. Retailing for less than \$150, the PalmScope sets a new affordability standard while providing a cost-effective way to visually inspect inaccessible or hazardous areas to assess and diagnose problems, or read hidden part and serial numbers. The video zoom button allows the user to zoom up to 4X, increasing the odds of spotting elusive problems. The 180-degree video flip function makes it easier to read upside-down labels and serial numbers by instantly turning them right-side up. Visit www.generaltools.com.

Bellaforte® by DAVINCI



Bellaforte roofing tiles have all the appearance and beauty of natural slate or shake, but with a higher level of durability from the proprietary-engineered polymer roofing formula. The tiles are designed for fast, easy installation, while protecting against the elements for decades to come. Bellaforte offers the discerning homeowner a level of style and beauty previously unattainable, backed by a 50-year limited warranty and made in the United States.



CLASS A Fire Rating

EASY INSTALLATION

50-YEAR WARRANTY

SLATE & SHAKE STYLES
to choose from in a wide
variety of color blends

VIRTUALLY
MAINTENANCE FREE



The Art & Science of Lasting Beauty

www.davinciroofscapes.com

HOT PRODUCTS

PLEDGE FLOORCARE WOOD FAMILY PRODUCTS

Wood floors can help transform a house into a home, adding warmth and beauty to any interior, whether traditional, contemporary or rustic. There's nothing quite like the appearance of clean wood floors, but daily traffic can leave them dull, dirty and scuffed.

The new Pledge FloorCare Wood family of products is designed specifically for wood flooring. Pledge FloorCare for Wood comes in four distinct product options: Pledge FloorCare Wood Concentrated Cleaner; FloorCare Wood Squirt & Mop; FloorCare Wood Trigger; and FloorCare Wood Finish. The products clean, shine, restore and protect precious wood floors, helping to sustain the beauty of your floors for years to come. Visit www.pledge.com.



BOSCH GLM 100 C LASER MEASURE WITH BLUETOOTH TECHNOLOGY

Using Bluetooth Wireless Technology, the new Bosch GLM 100 C Laser Measure instantly transfers measurements to smart phones and tablets with a free mobile application. Featuring an extended measuring distance (330 ft.), best-in-class memory storage and angle measurement in two axes, this laser-based range finder allows users to make accurate measurements that are instantly transferred to their smart devices. With the help of the app, professionals can easily store and manage measurements without relying on pen and paper, making it fast and easy to calculate material needs and estimate labor costs on-site.



Measurements also can be superimposed on jobsite photos, allowing users to quickly create and share detailed quotes containing pictures and comments. Boasting first-in-its-class remote control functionality, professionals can control the GLM 100 C from smart phones or tablets to make steady measurements along long range, short range targetless measurements, or in hard-to-reach spots. The GLM 100 C is accurate up to 1/16 inch. Visit www.boschtools.com.

ET SOLAR 300W POLYCRYSTALLINE SOLAR PANELS

Backwoods Solar offers great prices for off-grid and grid-tied projects. For years the company has been working closely with manufacturers to secure cosmetically blemished modules, and the mission is to find companies that continue to offer a warranty on the product, which protects the end user. By purchasing "B" grade modules, customers save money and still get a quality product. The slight cosmetic imperfections will not affect their performance. ET Solar guarantees excellent performance of the modules, even under limited light environments. The full 25-year power warranty is in effect on these modules, however, the 10-year "workmanship warranty" is waived (meaning that ET Solar will not replace the modules for cosmetic reasons). The ET Solar P672 series 300-watt panels provide excellent output with German manufacturing techniques using high-quality materials. Visit backwoodssolar.com.



Amsoil	39	Innerglass	18
Arke	17	Jacks Small Engines.....	30
Armstrong Clark	15	Kaddies	65
Bessey	22	Lumber Liquidators.....	6
Best Barns USA.....	84	Maze Nails.....	19
Bigfoot Systems	20	Milescraft.....	21
Blue Devil	34, 35	MP Global Products	51
Bristol Valley Hardwoods	68	Oneida Air Systems.....	67
Brush Weatherseal	71	Pine Hall Brick.....	33
Col-Met	63	Power Planter	69
Cox Wood.....	25	Rayovac	29
Custom Service Hardware	12	Ready Seal.....	10
DaVinci.....	85	Ryobi	64
Decks Unlimited	68	SafeRacks	50
Dixie Chopper	23	SafeWorld Int'l.....	81
DrainFixt	58	Sakrete	88
Drill Doctor	32	Sashco.....	13
Duck Tape	27	Screw Products	24
Duckback.....	9	Seal Krete	41
Earthway.....	79, BC	Simonton ProNetwork.....	55
Energy Saving Products	43	Specification Chemical.....	82
Evapo-Rust	18	Starrett	70
EZ Pro Perfect Pass	77	Summit	11
Flex-N-Fill	31	Super Soundproofing	82
FrogTape	47	Sure Drive USA	59
Fypon	83	Swanson	74
General Tools	IFC, 1	TG Tools.....	2, 3, IBC
Gorilla Tape	57	Tjernlund	16
Grizzly	66	Touch 'n Foam.....	7
GRK Fasteners	5	Trac Vac	76
Gutster Demo-Bar.....	56	Tub O' Towels	45
Hemp Shield	26	UGL.....	4
Howard Products.....	40	Under Deck Oasis	76
Hyde.....	49	Weed Razer.....	82
Ingram's Water & Air Equipment.....	73	X-treme Tape.....	69



Create something *concrete.*

The Pro's Choice since 1936



1.866.SAKRETE ♦ SAKRETE.COM

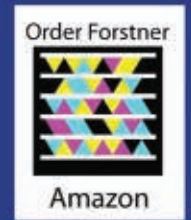
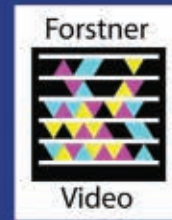

Spade

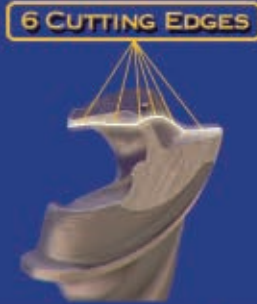

Brad

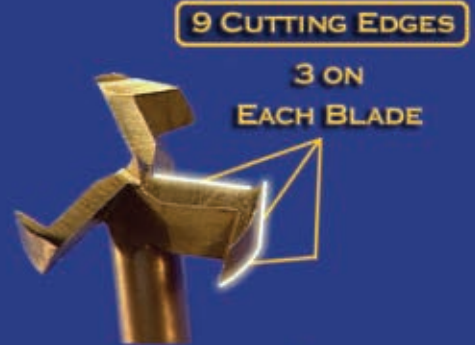

Forstner



When performance countsTG Tools United Co.
TGTools@sbcglobal.net or 800-687-4122 or www.mytgtools.com

SAVE MONEY with **Wood Heat**



- Furnace Heats in "Power Outages"
- Oil & Gas Backup
- 20-Year Warranty
- Super Efficient
- Free Domestic Hot Water

**MADE IN USA
SINCE 1972**

Call or write for factory direct catalog

Charmaster™

2307X Highway 2 West • Grand Rapids, Minnesota 55744
218-326-6786 • www.charmaster.com

EnderesTools

Quality Forged Hand Tools for a Lifetime

100 YEARS OF HISTORY



MADE IN THE USA!

Precision Ground • Professional Quality

For over 100 years, the employees at Enderes Tools have dedicated themselves to manufacturing the finest quality tools available on the market today.

Enderes Tools Guarantees that our tools will outperform the others. We give a full replacement guarantee if one ever fails it's designed function.

Spend your money wisely...

Buy Enderes!

1-800-874-7776



www.Enderes.com

Meet the Joint Chiefs



The E•Z Pro™ Mortise & Tenon Jig

lets you make perfectly matched mortise & tenon joints with one jig.

#870



The E•Z Pro™ Dovetail Jig

lets you make dovetail and box joints – through or half-blind.

#861

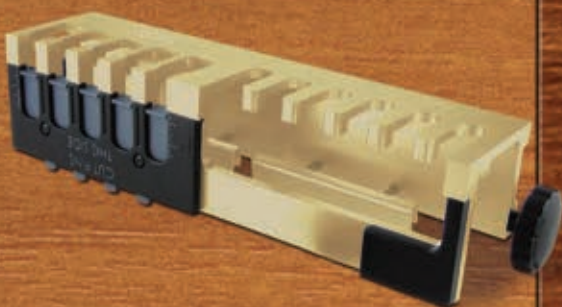

The E•Z Pro™ Pocket Hole Jig

has everything you need to make flush, corner and angle pocket hole joints.

#850



The E•Z Pro™ Doweling Jig

lets you make perfectly aligned dowel joints every time.

#851



Here's Our **Crowning Achievement**

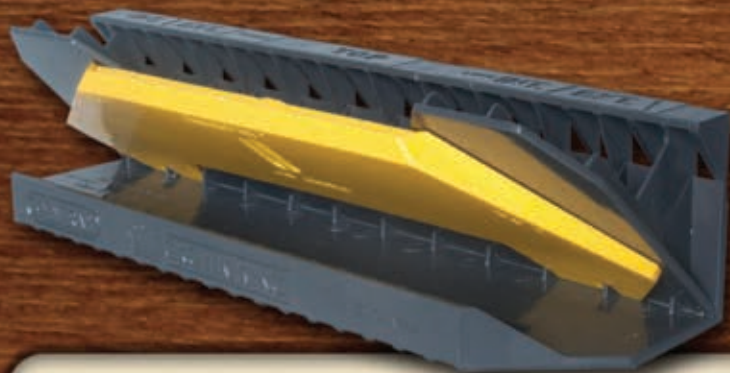

Crown King
helps you create seamless,
perfectly mitered interior
and exterior corner joints.
#880

Now you can make it yours!

The **Crown King** makes cutting crown molding joints a snap, eliminating trial and error and saving time and money. Unlike competitive jigs that require confusing upside-down miter box positioning or compound angle cutting, the molding in the jig is cut in the same alignment as it is installed on the wall. With just one base unit and a reversible insert, the jig enables woodworkers to produce interior and exterior corner joints for the three most common crown molding spring angles – 38, 45 and 52 degrees.

For more information on General's Crown King and our complete line of E•Z Pro™ jigs, visit:
generaltools.com/ckandjigs



Specialty Tools & Instruments

Precision, Specialty & Innovation...since 1922

Visit Us
at Booth
#5972



Meet the HandiBot™

smart power tool

from ShopBot Tools

An innovative, portable power tool run from apps on smartphones, tablets or PCs. The Handibot smart tool brings push-button CNC technology to jobsites and DIY projects!



Now, instead of taking material to a stationary CNC machine, you just bring the Handibot to your material:

- Work directly on a table, the floor, the ceiling, the wall, wherever cutting, drilling, carving, or other machining is needed
- Get the precision, repeatability and power of robotics and digital control
- Armed with a simple software app for the job you need to do, it's ready to go to work with a squeeze of the "Start" button

WATCH the Handibot at work:
[www.handibot.com/
video_scrapbook.html](http://www.handibot.com/video_scrapbook.html)

LEARN MORE and check out
pricing at www.handibot.com



ShopBot
handibot™

Handibot™ is a trademark of ShopBot Tools, Inc.